

ΤΡΑΝΣΦΟΡΜΑΤΟΡΥ ΤΟΚΑ

CURRENT TRANSFORMERS



S.A. DE CONSTRUCCIONES INDUSTRIALES



СОДЕРЖАНИЕ / CONTENTS

ОПРЕДЕЛЕНИЯ *DEFINITIONS*

ИЗМЕРИТЕЛЬНЫЕ ТРАНСФОРМАТОРЫ (В ПЛАСТИКОВОМ КОРПУСЕ) 2
MEASURING TRANSFORMERS (PLASTIC CASE)

ПЕРВИЧНАЯ ОБМОТКА / *WOUND PRIMARY* 3-4
ЭЛЕКТРИЧЕСКАЯ ШИНА / *BUS-BAR*

ИЗМЕРИТЕЛЬНЫЕ ТРАНСФОРМАТОРЫ (ЗАЛИТЫЕ СМОЛОЙ) 5-6
MEASURING TRANSFORMERS (ENCAPSULATED IN RESIN)

ИЗМЕРИТЕЛЬНОЕ ОБОРУДОВАНИЕ – СЧЕТЧИКИ ЭЛЕКТРОЭНЕРГИИ /
MEASURING EQUIPMENT - ENERGY METERS
ПЕРВИЧНАЯ ОБМОТКА – ЭЛЕКТРИЧЕСКАЯ ШИНА /
WOUND PRIMARY - BUS-BAR

ТРАНСФОРМАТОРЫ РАЗЪЕМНЫЙ СЕРДЕЧНИК 7
SPLIT CORE TRANSFORMERS

ИЗМЕРИТЕЛЬНЫЕ ТРАНСФОРМАТОРЫ (ЗАЛИТЫЕ СМОЛОЙ) 8-9
MEASURING TRANSFORMERS (ENCAPSULATED IN RESIN)

ЭЛЕКТРИЧЕСКАЯ ШИНА С УЗКИМ ПРОФИЛЕМ / *BUS-BAR - NARROW PROFILE*
ЭЛЕКТРИЧЕСКАЯ ШИНА С ПЛОСКИМ ПРОФИЛЕМ – (*FLAT BAR*)

ТРАНСФОРМАТОРЫ ДЛЯ РЕЛЕЙНОЙ ЗАЩИТЫ (В ПЛАСТИКОВОМ КОРПУСЕ) 10
PROTECTION TRANSFORMERS (PLASTIC CASE)

ТРАНСФОРМАТОРЫ ДЛЯ РЕЛЕЙНОЙ ЗАЩИТЫ (ЗАЛИТЫЕ СМОЛОЙ) 11-12
PROTECTION TRANSFORMERS (ENCAPSULATED IN RESIN)

ТРАНСФОРМАТОРЫ – ПРЕОБРАЗОВАТЕЛИ 13
TRAFO-TRANSDUCERS

СПЕЦИАЛЬНЫЕ ТРАНСФОРМАТОРЫ 14
SPECIAL TRANSFORMERS

ИТОГОВАЯ ТАБЛИЦА / *SUMMATION*
НАПРЯЖЕНИЕ / *VOLTAGE*

ТАБЛИЦА КОДОВ 15-16
CODES TABLE

ИЗМЕРИТЕЛЬНЫЕ ТРАНСФОРМАТОРЫ MEASURING TRANSFORMERS

Общие характеристики / General features

Рабочие стандарты / Operation standards

IEC 185	DIN 57414
UNE EN 60044-1	BS3938
VDE 0414	EN 50081-82
IEC 801/1-3.4	IEC - 1010

сертификаты:



Коэффициент безопасности: $F_s < 5$.
Номинальное напряжение: макс. 720 В.
Испытательное напряжение: 3 кВ (1 мин. при частоте электросети).
Частота: 50 ÷ 60 Гц.
Номинальное время короткого замыкания (по нагреву):
(Первичная обмотка) I_{th} : 60 In.
(Электрическая шина) ток I_{th} ограничен сердечником первичной обмотки.
Номинальный динамический ток: $I_{dyn} = 2,5 I_{th}$.
Непрерывная перегрузка: 1,2 In.

Rated voltage: 720 V max.
Test voltage: 3 KV for 1 min. at industrial frequency.
Frequency: 50 ÷ 60 Hz
Rated short-time thermal current:
Wound primary: I_{th} 60 In.
Busbar: I_{th} limited to primary bar.
Rated dynamic current: $I_{dyn} = 2,5 I_{th}$.
Continuous overload: 1,2 In.

ПЛАСТИКОВЫЙ КОРПУС PLASTIC CASE

Конструкция / Construction

Наши трансформаторы тока изготавливаются из высококачественных материалов. Соединительные клеммы вторичной обмотки выполняются из никелированной латуни, на каждой клемме имеется по два винта (ДВОЙНЫЕ КЛЕММЫ), что позволяет легко заменять приборы или выполнять иные операции на вторичной обмотке, не размыкая цепи.

Our Current Transformers are manufactured of high quality materials. The connection secondary terminals are made of nickel-plated brass, each terminal has two screws (DOUBLE TERMINAL) to allow easy replacement of instruments or any type of manipulation in the secondary without open-circuiting.

Корпус, выполненный из самозатухающего пластика, обладает прекрасной стойкостью к механическим и тепловым нагрузкам. Магнитные пластины с ориентированными зёрнами Fe-Si сплава, характеризующиеся высокой проницаемостью, специально рекомендованы изготовителем пластин для трансформаторов тока данного типа.

The self-extinguishing casing offers excellent resistance to mechanical and thermal stress. The magnetic plate is of high permeability grain oriented iron-silicon, specially recommended by the plate manufacturer for this type of CT's.

Система крепления, соответствующая стандарту DIN EN 50022/35 (поставляется отдельно).

Fastening system to DIN EN 50022/35 optional.

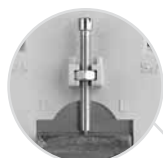

Крепление шины
Bus-bar fixing

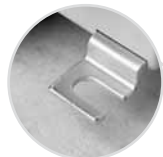

Крепление на панели
Fastening to panel

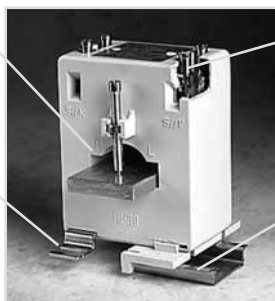

Двойная клемма
Double terminal

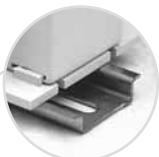

Крепление на DIN-направляющих
Fastening to DIN

КОНСТРУКЦИЯ И СХЕМА КРЕПЛЕНИЯ
CONSTRUCTION AND FASTENING DETAILS

КОРПУС ИЗ ЛИТЬЕВОЙ СМОЛЫ RESIN ENCAPSULATED

Введение / Introduction

Трансформаторы тока этого типа используются, главным образом, в низковольтных системах, эксплуатирующихся в помещениях, и в ваттметрах.

Использование смол, изоляционные характеристики которых намного превышают показатели обычных изоляционных материалов, в качестве наружного изолятора делает подобные трансформаторы тока компактными и прочными.

Основные характеристики трансформаторов тока этого типа являются следующими:

- Уровень огнестойкости V0.
- Высокая механическая прочность.
- Высокая прочность на пробой.
- Электролитическое покрытие для защиты от коррозии.
- Невозможен доступ к внутренним элементам.

These types of current transformers are mainly used in low voltage indoor installations and for watt-hour meters.

The use of resin as external isolator makes this C.T. compact and robust and of a much higher quality than any other type of conventional isolation.

The main features for this kind of C.T. are:

- V0 degree fire proof.
- High mechanical strength.
- High dielectric strength.
- Electrolytic anti-rust.
- Inner access not available.

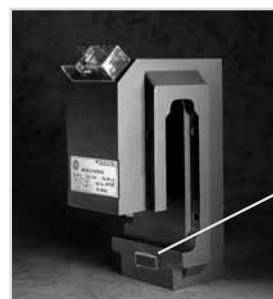

Смола
Resin

Сердечник
Core



Изоляция
Isolation

Обмотка
Wounded

ТРАНСФОРМАТОРЫ, ЗАЛИТЫЕ СМОЛОЙ
ENCAPSULATED TRANSFORMER SECTION

ИЗМЕРИТЕЛЬНЫЕ ТРАНСФОРМАТОРЫ (В ПЛАСТИКОВОМ КОРПУСЕ)

MEASURING TRANSFORMERS (Plastic Case)



TU3b-



TU-

Первичная обмотка / WOUND PRIMARY Шина/Bar Кабель/Cable	Первичная обмотка / WOUND PRIMARY								
	ТU3ba			ТU3b			ТU3bc		
	1	3	5	1	3	5	1	3	5
	ВА			ВА			ВА		
Класс/Class	1	3	5	1	3	5	1	3	5
Ирп (А)									
5	5	7,5		10	20	30	15	25	40
10	5	7,5		10	20	30	15	25	40
15	5	7,5		10	20	30	15	25	40
20	5	7,5		10	20	30	15	25	40
25	5	7,5		10	20	30	15	25	40
30	5	7,5		10	20	30	15	25	40
40	5	7,5		10	20	30	15	25	40
50	5	7,5		10	20	30	15	25	40
60	5	7,5		10	20	30	15	25	40
75	5	7,5		10	20	30	15	25	40
100				10	20	30	15	25	40
125				10	20	30	15	25	40
150				10	20	30	15	25	40
200									
250									
300									
400									
500									
600									
750									
800									
1000									

Электрическая шина / BUS-BAR								
20x5			30x10			40x10		
Ø 16			Ø 22			Ø 30		
ТU20			ТU30			ТU40		
0,5	1	3	0,5	1	3	0,5	1	3
ВА			ВА			ВА		
			1					
			1					
			1			0,75 1,5		
1			2			1,25 2		
1,5 2,5						2 3,75		
2,5 3,75			1,25 2,5			1 3 5		
3,75 5			1,25 2,5			2,5 3,75 5		
3,75 5 7,5			1,5 2,5 3,75			3,75 5 7,5		
5 7,5 10			2,5 3,75 5			3,75 5 7,5		
7,5 10 15			3,75 5 7,5			5 7,5 10		
			3,75 5 7,5			7,5 10 15		
			3,75 5 7,5			10 15 20		
			5 7,5 10			10 15 20		
			5 7,5 10			10 15 20		
						10 15 20		
						15 20 30		
						15 20 30		

РАЗМЕРЫ / DIMENSIONS

Опора для крепления / Fixing support

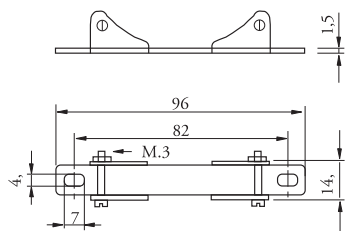

Cотас en mm./ Размеры, мм	Модель / Models					
	ТU3ba		ТU3b		ТU3bc	
	5/5 а 25/5	30/5 а 75/5	5/5 а 25/5	30/5 а 150/5	5/5 а 25/5	30/5 а 150/5
A	4		5		6	
B	8	9	9	10	10	11
C	10	11	11	12	12	13
D	M	M.1	M	M.1	M	M.1

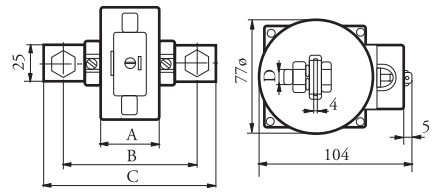

ТU3ba -TУ3b -TУ3bc

TU-

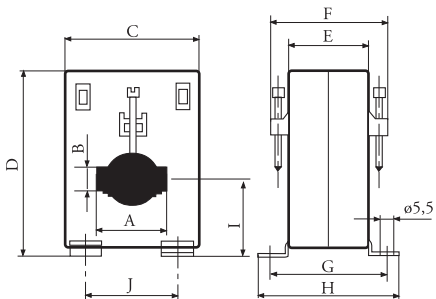

TU20



Рис. 1

TU30

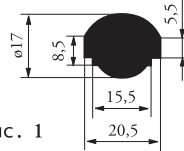

Рис. 2

TU40

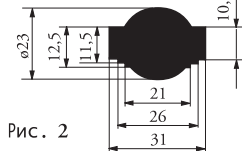

Рис. 3

Модель / Model	A	B	C	D	E	F	G	H	I	J
TU20	Рис. 1	56	74	33	48,5	48,5	60	32,5	37	
TU30	Рис. 2	60	79	36	51,5	51,5	63	34,5	41	
TU40	Рис. 3	71	96	45,5	61	61	72,5	44,5	52	

ИЗМЕРИТЕЛЬНЫЕ ТРАНСФОРМАТОРЫ (В ПЛАСТИКОВОМ КОРПУСЕ) MEASURING TRANSFORMERS (Plastic Case)

ЭЛЕКТРИЧЕСКАЯ ШИНА / BUS-BAR								
Шина/Bar	30x10	40x10	60x10	80x30	100x20	100x30	100x60	
Кабель/Cable	Ø 25	Ø 32	Ø 51	Ø 65	Ø 20	Ø 30	Ø 60	
Модели/Models	TUC30	TUC40	TUC60	TUC80	TL2	TL3	TL4	
Класс/Class	0,5 1 3	0,5 1 3	0,5 1 3	0,5 1 3	0,5 1 3	0,5 1 3	0,5 1 3	
Ирп (A)	ВА	ВА	ВА	ВА	ВА	ВА	ВА	
50		1,5 2,5						
60		2 3						
75		2,5 3,75						
100		3,75 5 7,5						
125		3,75 5 7,5						
150		3,75 5 7,5						
200	15 20 30	3,75 5 7,5						
250	15 20 30	5 7,5 10						
300	15 20 30	7,5 10 15						
400	15 20 30	10 15 20	15 20 30	15 20 30				
500	15 20 30	10 15 20	15 20 30	15 20 30				
600	15 20 30	10 15 20	15 20 30	15 20 30				
750		10 15 20	15 20 30	15 20 30	10 20 30			
800		15 20 30	15 20 30	15 20 30	15 20 30			
1000		15 20 30	15 20 30	15 20 30	20 30 45			
1200			15 20 30	15 20 30	20 30 45			
1500			15 20 30	15 20 30	30 45 60	10 20 30		
2000			15 20 30	15 20 30	30 60 90	15 25 40	10 20 30	
2500				15 20 30		25 30 45	10 20 30	
3000						30 45 60	20 30 45	
4000							30 60 90	
5000							30 60 90	

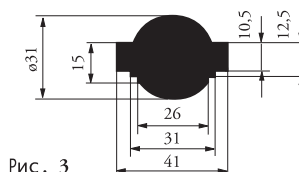

TUC30



TUC60



TL

РАЗМЕРЫ / DIMENSIONS

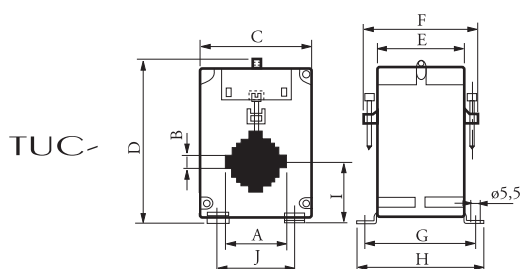

TUC30



Рис. 1

TUC40

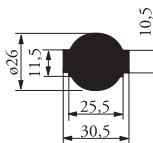

Рис. 2

TUC60

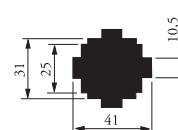

Рис. 3

TUC80

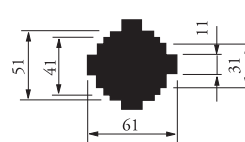

Рис. 4

Модель/Model	A	B	C	D	E	F	G	H	I	J
TUC30	Рис. 1		77	112	60,5	76	76	87,5	44,5	41
TUC40	Рис. 2		71	106,5	45	61	60,5	72	40	47
TUC60	Рис. 3		105	136,5	60	76	75,5	87	54	81
TUC80	Рис. 4		131	161,5	60	76	75,5	87	69	107

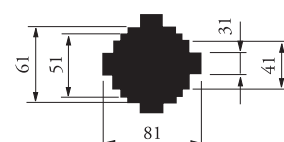
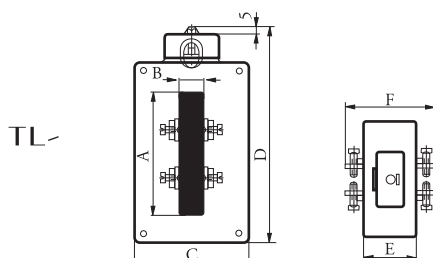

Модель/Model	A	B	C	D	E	F
TL2	102	20	94	178	38	66
TL3	103	32	114	210	45	71
TL4	104	62	156	224	50	78

ИЗМЕРИТЕЛЬНЫЕ ТРАНСФОРМАТОРЫ (ЗАЛИТЫЕ СМОЛОЙ) MEASURING TRANSFORMERS (RESIN ENCAPSULATED) ИЗМЕРИТЕЛЬНОЕ ОБОРУДОВАНИЕ – СЧЕТЧИКИ ЭЛЕКТРОЭНЕРГИИ MEASURING EQUIPMENT - ENERGY METERS



TU3R



TUP20R

	ПЕРВИЧНАЯ ОБМОТКА WOUND PRIMARY	ЭЛЕКТРИЧЕСКАЯ ШИНА BUS-BAR
Шина/Bar		100x20
Кабель/Cable		Ø 20
Модели/Models	TU3R	TUP20R
Класс/Class	0,5 S	0,5 S
Ирп (A)	BA	BA
50	10	
60	10	
75	10	
100	10	
125	10	
150	10	
200	10	
250	10	
300	10	
400	10	
500	10	
600	10	
750		10
800		10
1000		10
1200		10
1500		10
2000		10

РАЗМЕРЫ / DIMENSIONS

Опора для крепления
Fixing support

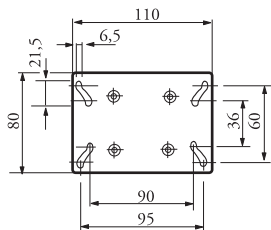

TU3R

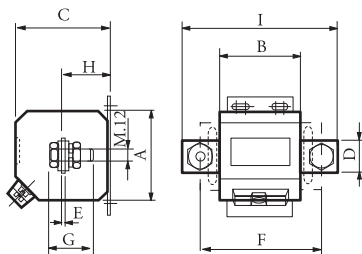

Модели Model	Отношение Ratio	A	B	C	D	E	F	G	H	I
TU3R	50/5-300/5	80	73,5	96	30	5	110	38	42	140
	400/5-600/5	80	73,5	101	30	10	110	48	47	140

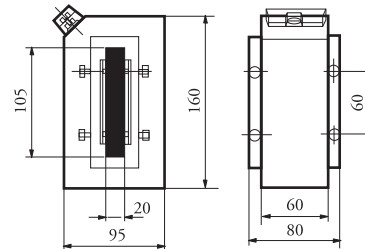

TUP20R

ИЗМЕРИТЕЛЬНЫЕ ТРАНСФОРМАТОРЫ (залитые смолой) MEASURING TRANSFORMERS (RESIN ENCAPSULATED)

Шина/Bar Кабель/Cable	ПЕРВИЧНАЯ ОБМОТКА WOUND PRIMARY			ЭЛЕКТРИЧЕСКАЯ ШИНА BUS-BAR			
	TU3bR	TU3R	TU50R	80x20 Ø 20	100x20 Ø 20	100x60 Ø 60	100x95 Ø 95
Модели/Models				TUP20RC	TUP20R	TUP60R	TUP95R
Класс/Class Ipn (A)	0,5 1 BA	0,5 1 BA	0,5 1 BA	0,5 1 BA	0,5 1 BA	0,5 1 BA	0,5 1 BA
5/5 а 40/5	10 20						
50	10 20	15 25					
60	10 20	15 25					
75	10 20	15 25					
100	10 20	15 25					
125	10 20	15 25					
150	10 20	15 25					
200	10 20	15 25					
250		15 25					
300		15 25					
400		15 25	15 25				
500		15 25	15 25	10 15			
600		15 25	15 25	15 25			
750			15 25	15 25	15 25		
800			15 25	15 25	15 25		
1000				15 25	15 25		
1200				15 25	15 25		
1500				15 25	15 25		
2000					15 25	15 25	
2500						15 25	
3000						15 25	15 25
4000						15 25	15 25
5000							15 25



TU3bR



TU3R



TUP20RC



TUP-R

РАЗМЕРЫ / DIMENSIONS

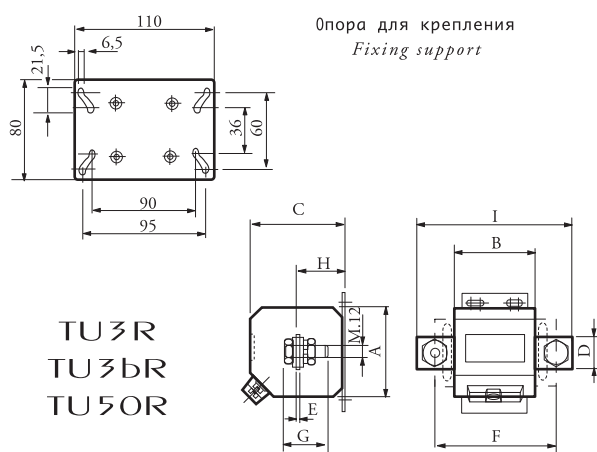

Модели Model	Отношение Ratio	A	B	C	D	E	F	G	H	I
TU3R	50/5-300/5	80	73,5	96	30	5	110	38	42	140
	400/5-600/5	80	73,5	101	30	10	110	48	47	140
TU3bR	5/5-200/5	77	55	86	24	4	100	32	42	126
TU50R	400/5-800/5	100	75	100	50	10	135	48	50	175

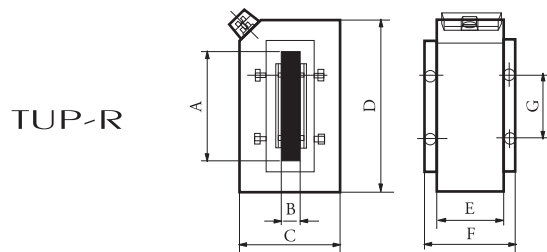
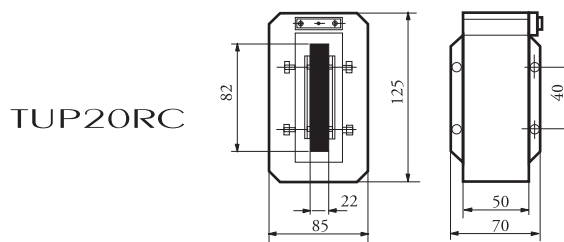

Модели/Model	A	B	C	D	E	F	G
TUP20R	105	20	95	160	60	80	60
TUP60R	105	60	150	193	60	80	60
TUP95R	105	95	200	200	60	80	60

ИЗМЕРИТЕЛЬНЫЕ ТРАНСФОРМАТОРЫ (залитые смолой) MEASURING TRANSFORMERS (RESIN ENCAPSULATED)



РАЗЪЕМНЫЙ СЕРДЕЧНИК / SPLIT CORE						
Шина/Bar	30x20	60x30	80x50	100x80	125x80	160x80
Кабель/Cable	Ø 20	Ø 30	Ø 50	Ø 80	Ø 80	Ø 80
Модели/Models	TA30R	TA60R	TA80R	TA100R	TA125R	TA160R
Класс/Class	0,5 1 3	0,5 1 3	0,5 1 3	0,5 1 3	0,5 1 3	0,5 1 3
Ірп (A)	ВА	ВА	ВА	ВА	ВА	ВА
100	3					
150	3,75					
200	2,5 4					
250	3,75 5	1 2,5 3,75	1 2,5 3,75	1 2,5 3,75		
300	2,5 4 6	2 3,75 5	2 3,75 5	2 3,75 5		
400	3,75 5 10	2,5 3,75 7,5	2,5 3,75 7,5	2,5 3,75 7,5		
500		3,75 5 15	3,75 5 15	3,75 5 15	1,2 5 7,5	2,5 3,75 7,5
600		5 7,5 20	5 7,5 20	5 7,5 20	1,2 5 15	2,5 3,75 7,5
750		7,5 10 20	7,5 10 20	7,5 10 20	5 10 20	5 10 20
800		7,5 10 20	7,5 10 20	7,5 10 20	7,5 10 20	7,5 10 20
1000		10 15 20	10 15 20	10 15 20	10 20 30	10 20 30
1200				15 20 30	15 20 30	15 20 30
1500				15 20 30	20 30 45	20 30 45
2000				20 30 45	25 30 45	25 30 45
2500					25 30 45	25 30 45
3000					30 45 60	30 45 60
4000						30 45 60
5000						30 45 60

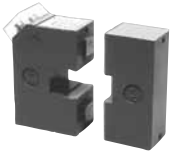

TA30R



TA80R



TA160R

РАЗМЕРЫ / DIMENSIONS

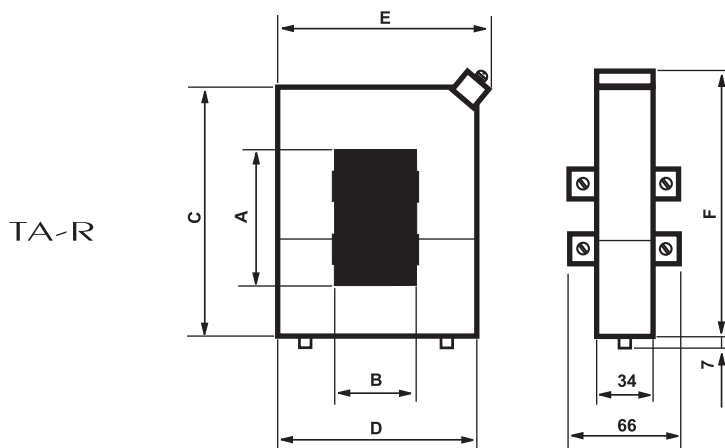

Модели/Model	A	B	C	D	E	F
TA30R	32	22	100	90	99	109
TA60R	62	32	130	100	109	139
TA80R	82	52	150	120	129	159
TA100R	104	82	172	150	159	181
TA125R	127	82	195	150	159	204
TA160R	162	82	230	150	159	239

ИЗМЕРИТЕЛЬНЫЕ ТРАНСФОРМАТОРЫ (залитые смолой) MEASURING TRANSFORMERS (RESIN ENCAPSULATED) узкий профиль / NARROW PROFILE

ЭЛЕКТРИЧЕСКАЯ ШИНА / BUS BAR								
Шина/Bar	30x20	60x30	80x50	100x80	125x80	160x80	100x20	125x35
Кабель/Cable	Ø 20	Ø 30	Ø 50	Ø 80	Ø 80	Ø 80	Ø 20	Ø 35
Модели/Models	TU30R	TU60R	TU80R	TU100R	TU125R	TU160R	TU100RT	TU125RT
Класс/Class	0,5 1 3	0,5 1 3	0,5 1 3	0,5 1 3	0,5 1 3	0,5 1 3	0,5 1 3	0,5 1 3
Ипрп (A)	ВА	ВА	ВА	ВА	ВА	ВА	ВА	ВА
100	3,75							
150	3,75 5							
200	5 7,5							
250	5 7,5 10	2,5 3,75 5	2,5 3,75 5	2,5 3,75 5				
300	5 7,5 10	3,75 5 7,5	3,75 5 7,5	3,75 5 7,5				
400	7,5 10 15	5 7,5 10	5 7,5 10	5 7,5 10				
500		7,5 10 15	7,5 10 15	7,5 10 15	10 15 20	10 15 20		
600		10 15 20	10 15 20	10 15 20	15 20 30	15 20 30		
750		15 20 30	15 20 30	15 20 30	15 20 30	15 20 30	10 20 30	
800		15 20 30	15 20 30	15 20 30	15 20 30	15 20 30	15 20 30	7,5 10 15
1000		15 20 30	15 20 30	15 20 30	15 20 30	15 20 30	20 30 45	7,5 10 15
1200				15 20 30	15 20 30	15 20 30	20 30 45	7,5 10 15
1500				15 20 30	15 20 30	15 20 30	30 45 60	10 15 20
2000				15 20 30	15 20 30	15 20 30	30 60 90	15 20 30
2500					15 20 30	15 20 30		20 25 30
3000					15 20 30	15 20 30		25 30 45
4000						15 20 30		30 40 60
5000						15 20 30		



TU-R



TU-RT

РАЗМЕРЫ / DIMENSIONS

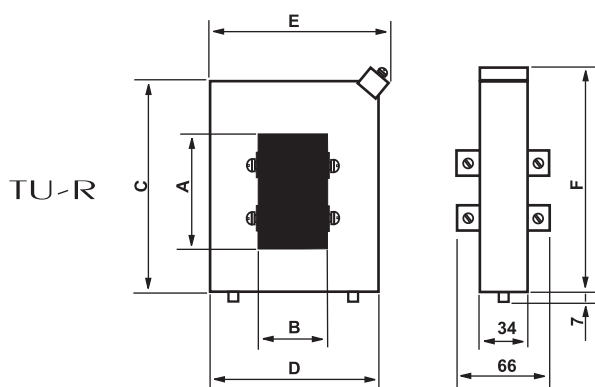

Модели/Model	A	B	C	D	E	F
TU30R	32	22	100	90	99	109
TU60R	62	32	130	100	109	139
TU80R	82	52	150	120	129	159
TU100R	104	82	172	150	159	181
TU125R	127	82	195	150	159	204
TU160R	162	82	230	150	159	239

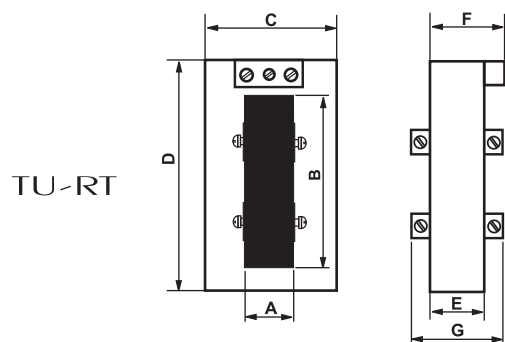

Модели/Model	A	B	C	D	E	F	G
TU100RT	22	101	83	145	40	55	66
TU125RT	38	127	97	170	40	55	66

ИЗМЕРИТЕЛЬНЫЕ ТРАНСФОРМАТОРЫ (залитые смолой) MEASURING TRANSFORMERS (RESIN ENCAPSULATED)



узкий профиль / NARROW PROFILE

ЭЛЕКТРИЧЕСКАЯ ШИНА / BUS-BAR							
Шина/Bar	40x10	40x10	60x15	80x50	100x60	125x80	
Кабель/Cable	Ø 25	Ø 36	Ø 45	Ø 50	Ø 60	Ø 80	
Модели/Models	TU40RS	TU40RSD	TU60RS	TU80RS	TU100RS	TU125RS	
Класс/Class	0,5 1 3	0,5 1 3	0,5 1 3	0,5 1 3	0,5 1 3	0,5 1 3	
I _{pn} (A)	ВА	ВА	ВА	ВА	ВА	ВА	
200		5 7,5 10					
250		5 7,5 10					
300	10 15 20	10 15 20					
400	10 15 20	10 15 20	5 7,5 10	5 7,5 10			
500	10 15 20	10 15 20	7,5 10 15	7,5 10 15			
600	10 15 20	10 15 20	10 15 20	10 15 20			
750	10 15 20	10 15 20	10 15 20	10 15 20	15 20 30		
800	10 15 20	10 15 20	10 15 20	10 15 20	15 20 30		
1000	10 15 20	10 15 20	10 15 20	10 15 20	15 20 30		
1200			10 15 20	10 15 20	15 20 30		
1500			15 20 30	15 20 30	15 20 30		
2000			15 20 30	15 20 30	15 20 30	15 20 30	
2500				15 20 30	15 20 30	15 20 30	15 20 30
3000					15 20 30	15 20 30	15 20 30
4000						15 20 30	15 20 30
5000						15 20 30	15 20 30
6000						15 20 30	15 20 30



TU40RS



TU40RSD



TU-RS

РАЗМЕРЫ / DIMENSIONS

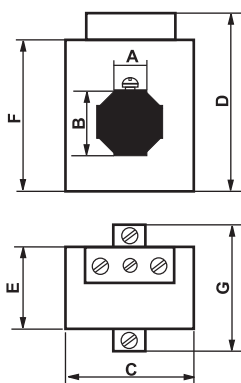

TU40RS



Рис. 1

TU40RSD

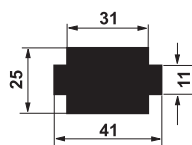

Рис. 2

TU60RS

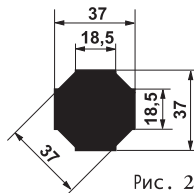

Рис. 3

Модель/Model	A	B	C	D	E	F	G
TU40RS	Рис. 1	72	100	46	85	71	
TU40RSD	Рис. 2	72	100	46	85	71	
TU60RS	Рис. 3	90	115	40	100	66	

TU-RS

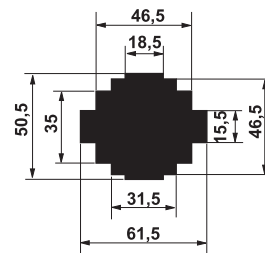
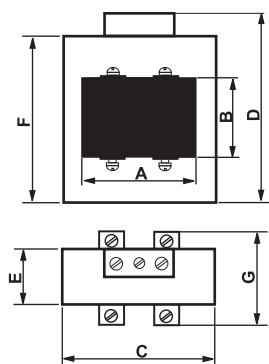

Модель/Model	A	B	C	D	E	F	G
TU80RS	82	57	110	135	40	120	66
TU100RS	102	62	140	153	34	130	66
TU125RS	127	82	165	189	42	166	66

ИЗМЕРИТЕЛЬНЫЕ ТРАНСФОРМАТОРЫ (В ПЛАСТИКОВОМ КОРПУСЕ) MEASURING TRANSFORMERS (PLASTIC CASE)

ПЕРВИЧНАЯ ОБМОТКА WOUND PRIMARY		ЭЛЕКТРИЧЕСКАЯ ШИНА BUS-BAR					
Шина/Bar		30x10	60x10	80x30	100x20	100x30	100x60
Кабель/Cable		Ø 25	Ø 51	Ø 65	Ø 20	Ø 30	Ø 60
Модели/Models	TUЗbc	TUC30	TUC60	TUC80	TL2	TL3	TL4
Класс/Class	5P10 10P10	5P10 10P10	5P10 10P10	5P10 10P10	5P10 10P10	5P10 10P10	5P10 10P10
Ірп (A)	ВА	ВА	ВА	ВА	ВА	ВА	ВА
50	3,5 3,5						
60	3,5 3,5						
75	3,5 3,5						
100	3,5 3,5						
125	3,5 3,5						
150	3,5 3,5						
200		3,5 5	3,5 3,5	3,5 3,5			
250		5 5	3,5 3,5	3,5 3,5			
300		5 7,5	5 5	5 5			
400			5 5	5 5			
500			5 7,5	5 7,5			
600			7,5 10	7,5 10			
750			7,5 10	7,5 10			
800			10 10	10 10			
1000			10 10	10 10			
1200			10 10	10 10			
1500			10 12,5	10 12,5			
2000			10 12,5	10 12,5	5 7,5		
2500					5 7,5	7,5 10	
3000						7,5 10	5 7,5
4000							7,5 10
5000							7,5 10



TUЗbc



TUC-



TL-

РАЗМЕРЫ / DIMENSIONS

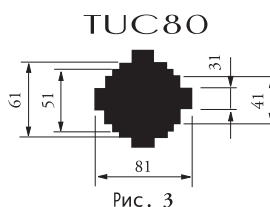
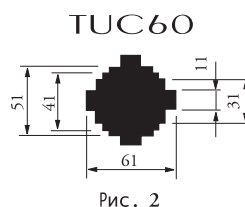
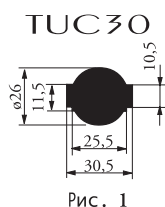
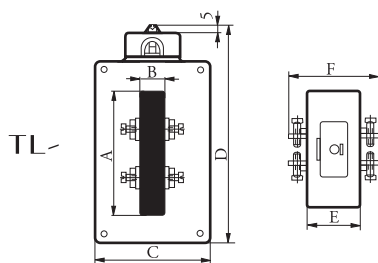
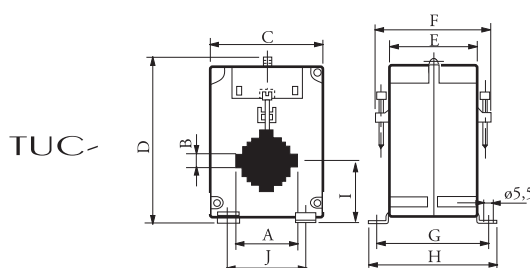
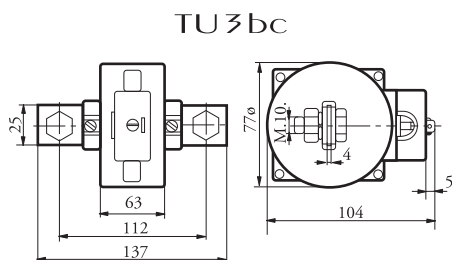

Модели/Model	A	B	C	D	E	F
TL2	102	20	94	178	38	66
TL3	103	32	114	210	45	71
TL4	104	62	156	224	50	78

Модели/Model	A	B	C	D	E	F	G	H	I	J
TUC30	Рис. 1		77	112	60,5	76	76	87,5	44,5	41
TUC60	Рис. 2		105	136,5	60	76	75,5	87	54	81
TUC80	Рис. 3		131	161,5	60	76	75,5	87	69	107

ТРАНСФОРМАТОРЫ РЕЛЕЙНОЙ ЗАЩИТЫ (ЗАЛИТЫЕ СМОЛОЙ) PROTECTION TRANSFORMERS (RESIN ENCAPSULATED)



ПЕРВИЧНАЯ ОБМОТКА WOUND PRIMARY

Шина / Bar
Кабель / Cable

Модели / Models	TU3PR	TU50R
Класс / Class	5P10 10P10	5P10 10P10
Ирп (A)	ВА	ВА
50	10 10	
60	10 10	
75	10 10	
100	10 10	
125	10 10	
150	10 10	
200	10 10	
250	10 10	
300	10 10	
400	10 10	
500	10 10	7,5 7,5
600	10 10	7,5 7,5
750		12,5 12,5
800		12,5 12,5
1000		
1200		
1500		
2000		
2500		
3000		
4000		
5000		

ЭЛЕКТРИЧЕСКАЯ ШИНА BUS-BAR

80x20 Ø 20		100x20 Ø 20		100x60 Ø 60		100x95 Ø 95	
Модели / Models	TUP20RC	TUP20R	TUP60R	TUP95R			
Класс / Class	5P10 10P10	5P10 10P10	5P10 10P10	5P10 10P10			
Ирп (A)	ВА	ВА	ВА	ВА			
3,5	3,5						
3,5	3,5						
3,5	3,5	7,5 10					
3,5	3,5	7,5 10					
5	5	12,5 15	12,5 15				
		15 15	15 15				
		15 20	15 20				
		15 20	15 20				
			15 20				
			20 30	15 20			
				20 30			
				20 30			



TU3PR



TUP20RC



TUP-R

РАЗМЕРЫ / DIMENSIONS

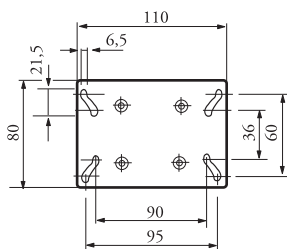

Опора для крепления
Fixing support

TU3-R

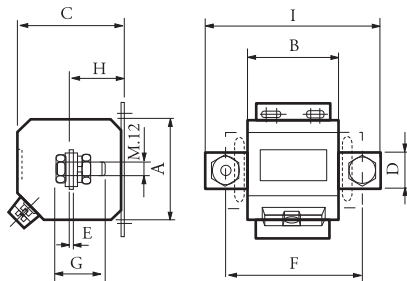

TUP20RC

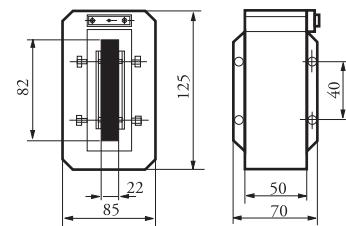

TUP-R

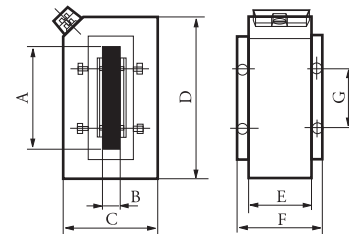

Модели / Model	Relacion	A	B	C	D	E	F	G	H	I
TU3PR	50-300/5	100	75	110	30	5	110	38	55	140
TU3PR	400-600/5	100	75	110	30	10	110	48	60	140
TU50R	500-800/5	100	75	100	50	10	135	48	50	175

Модели / Model	A	B	C	D	E	F	G
TUP20R	105	20	95	160	60	80	60
TUP60R	105	60	150	193	60	80	60
TUP95R	105	95	200	200	60	80	60

ТРАНСФОРМАТОРЫ РЕЛЕЙНОЙ ЗАЩИТЫ (ЗАЛИТЫЕ СМОЛОЙ) PROTECTION TRANSFORMERS (RESIN ENCAPSULATED)

	ЭЛЕКТРИЧЕСКАЯ ШИНА BUS-BAR							
Кабель / Cable	Ø 60		Ø 80		Ø 100		Ø 125	
Modelos/Models	TPR60		TPR80		TPR100		TPR125	
Класс / Class	5P10	5P20	5P10	5P20	5P10	5P20	5P10	5P20
Ірп (A)	BA		BA		BA		BA	
100	10	5						
150	15	7						
200	20	10						
250	25	12	12	5				
300	30	15	15	7				
400	40	20	22	10				
500	50	25	30	12	15	7		
600	60	30	35	15	15	8		
750	75	38	45	18	20	10		
800	80	40	48	20	25	12		
1000	100	50	48	20	30	15	20	10
1200			48	22	30	17	30	15
1500			73	28	40	20	30	15
2000			97	35	60	30	30	15
2500					65	35	40	20
3000					65	35	40	20
4000					80	45	50	25
5000					120	70	70	35



TUPR60

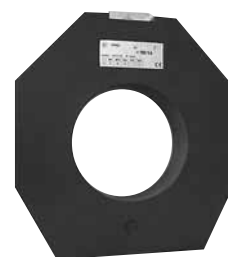

TUPR80

РАЗМЕРЫ / DIMENSIONS

Опора для крепления
Fixing support

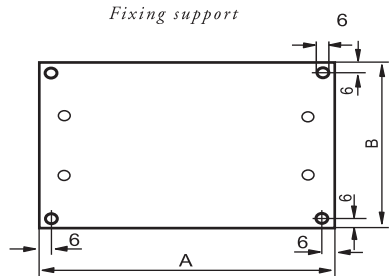

Модели / Model	A	B
TPR60	124	120
TPR80	136	100
TPR100	150	100
TPR125	166	100

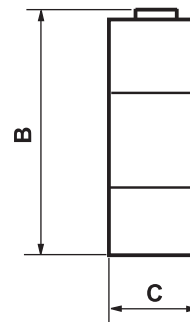
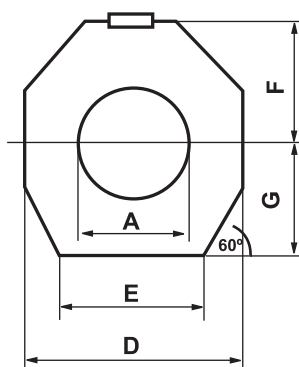

Модели / Model	A	B	C	D	E	F	G
TPR60	62	211	80	185	124	110	93
TPR80	82	231	60	205	136	120	103
TPR100	102	251	60	225	150	130	113
TPR125	127	276	60	250	166	143	125

ТРАНСФОРМАТОРЫ – ПРЕОБРАЗОВАТЕЛИ TRANSFORMERS-TRANSUDCERS

Технические характеристики:
Класс точности 1%.
Рабочий диапазон 0-120%
Частота 50-60 Гц
Макс сопротивление нагрузки:
600 Вт (24 В)
Время отклика <200 мс.

Technical specifications:
Accuracy class 1%.
Operating range 0-120%
Frequency 50-60 Hz.
Maximum load impedance 600 Ω (24V)
Response time <200 ms.



TC40

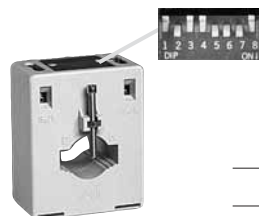

TC-CV

Моделл/Models	ЭЛЕКТРИЧЕСКАЯ ШИНА (0-20 МА) BUS BAR (0-20 mA)			ЭЛЕКТРИЧЕСКАЯ ШИНА (4-20 МА) BUS BAR (4-20 mA)			
	Шина/Bar	40x10	60x10	80x30	20x5	30x10	40x10
Кабель/Cable	Ø 30	Ø 51	Ø 65	Ø 16	Ø 22	Ø 30	
Класс/Class	МА	МА	МА	МА	МА	МА	
I_{pn} (A)	50	20					
	60	20					
	75	20					
	100	20					
	125	20					
	150	20					
	200	20					
	250	20					
	300	20					
	400	20	20	20			
	500		20	20			
	600		20	20			
	750		20	20			
	800		20	20			
	1000		20	20			
	1200		20	20			
	1500		20	20			
	2000		20	20			
	2500			20			
	10; 12,5; 15 ó 20				4-20		
	20; 25; 30 ó 40				4-20	4-20	
	50; 65; 75 ó 400				4-20	4-20	4-20
	125; 150; 200 ó 250				4-20	4-20	4-20
	300; 400; 500 ó 600					4-20	4-20

НАПРЯЖЕНИЕ ПИТАНИЯ 10-40 В =
SUPPLY VOLTAGE 10-40 V.d.c.

РАЗМЕРЫ / DIMENSIONS

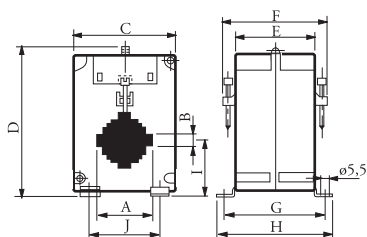

РАЗМЕРЫ / Dimensions pag. 4
TUC40 - TUC60 - TUC80



Рис. 2



Рис. 3

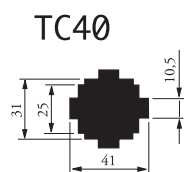

Рис. 4

Схема соединений
Connection diagram

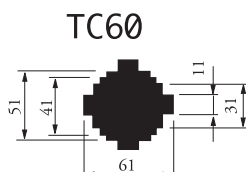

РАЗМЕРЫ / Dimensions pag. 3
TU20 - TU30 - TU40

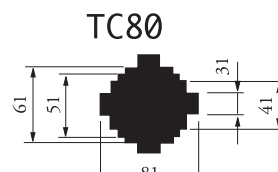
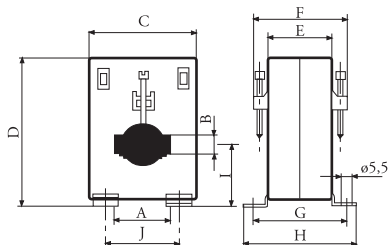
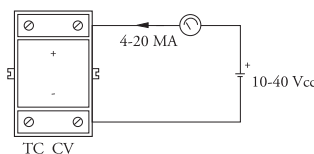

Рис. 1



Рис. 2

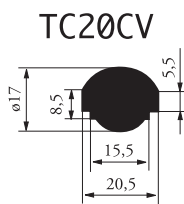

Рис. 3

СПЕЦИАЛЬНЫЕ ТРАНСФОРМАТОРЫ SPECIAL TRANSFORMERS

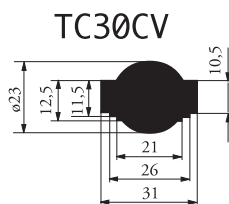
СУММИРОВАНИЕ ТРАНСФОРМАТОРОВ ТОКА SUMMATION CURRENT TRANSFORMERS

Векторы токов вторичной и первичной обмоток суммируются.

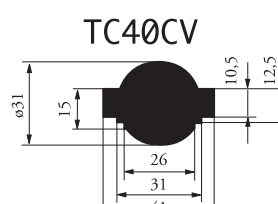
The secondary current is the vectorial addition of primary currents.



TRS2

Модели/Models		
Класс/Class	0,5	
И _{рп} (A)	BA	
5+5/5	10	TRS2
5+5+5/5	10	TRS3
5+5+5+5/5	10	TRS4
5+5+5+5+5/5	10	TRS5

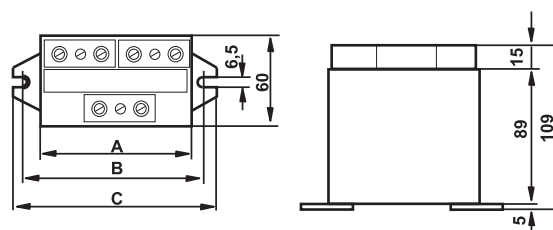

Модель/Model	A	B	C
TRS2	100	119	135
TRS3	100	119	135
TRS4	150	169	185
TRS5	150	169	185

ТРАНСФОРМАТОРЫ НАПРЯЖЕНИЯ VOLTAGE TRANSFORMERS

ЗАЛИТЫЙ СМОЛОЙ / ENCAPSULATED IN RESIN

Исполнение для кораблестроения / *naval serie*

Рабочий диапазон (V_{рп}) 80-120%

Нагрузка 25-100% (при cos 0,8)

Operating range (V_{рп}) 80-120%

Load 25-100% (for cos 0,8)



TE15R

Модели/Model	TE15R
Класс/Class	1
V _р /V _с	BA
440/220	25
440/110	25
440/100	25
380/220	25
380/110	25
380/100	25
220/100	25

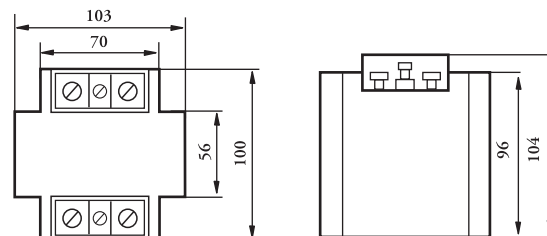

Опора для крепления
Fixing support

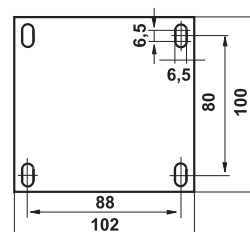

ПЛАСТИКОВЫЙ КОРПУС
PLASTIC CASE

Модели	TU3ba	TU3b	TU3bc	TU20	TU30	TUC30	TU40	TUC40	TUC60	TUC80	TU2	TU3	TU4
Первичная обмотка	20x5 30x10 30x10 40x10 40x10 60x10 80x30 100x20 100x30 100x60												
Wound primary	16 22 25 30 32 51 65 20 30 60												
Ipn (A)/pág.	3 3 3 3 3 4 3 4 4 4 4 4 4												
КОДЫ	T01A-T02A-T03A-T23A-T24A-T26A-T25A-T27A-T28A-T29A-T11A-T12A-T13A-												
5	03	03	03										
10	06	06	06										
15	09	09	09										
20	12	12	12										
25	15	15	15										
30	18	18	18	18									
40	21	21	21	21									
50	24	24	24	24			24	24					
60	27	27	27	27			27	27					
75	30	30	30	30			30	30					
100		33	33	33	33		33	33					
125		36	36	36	36		36	36					
150		39	39	39	39		39	39					
200			42	42	43	42	42						
250			45	45	45	45	45						
300				48	48	48	48						
400				51	51	51	51	52	52				
500				54	54	54	54	55	55				
600				57	57	57	57	58	58				
750						60	60	61	61	60			
800						63	63	64	64	63			
1000						66	66	67	67	66			
1200								70	70	69			
1500								73	73	72	72		
2000								76	76	75	75	75	
2500								79	78	78			
3000									81	81			
4000										84			
5000										87			

ЗАЛИТЫЙ СМОЛОЙ
RESIN

Модели	TU3bR	TU3R	TU50R	TUP20RC	TUP20R	TUP60R	TUP95R
Первичная обмотка	80x20 100x20 100x60 100x95						
Wound primary	20 20 60 95						
Ipn (A)/pág.	6 6 6 6 6 6 6						
КОДЫ	T15A-T14A-T16A-T30N-T17A-T18A-T19A-						
03							
06							
09							
12							
15							
18							
21							
24	24						
27	27						
30	30						
33	33						
36	36						
39	39						
42	42						
45	45						
48	48						
51	51						
54	54	54					
57	57	57					
60	60	60	60				
63	63	63	63				
66	66	66	66				
69	69	69	69				
72	72	72	72				
75	75	75	75				
78	78	78	78				
81	81	81	81				
84	84	84	84				
87	87	87	87				

УЗКИЙ ПРОФИЛЬ / СМОЛА
NARROW PROFILE / RESIN

Модели	TU30R	TU60R	TU80R	TU100R	TU125R	TU160R	TU40RS	TU40RSD	TU60RS	TU80RS	TU100RS	TU125RS	TU100RT	TU125RT
Первичная обмотка	30x20 60x30 80x50 100x80 125x80 160x80 40x10 40x10 60x15 80x50 100x60 125x80 100x20 125x35													
Ipn (A)/pág.	20 30 50 80 80 80 25 36 45 50 60 80 20 35													
КОДЫ	T03I- T06I- T08I- T10I- T12I- T16I- T04I- T05I- T07I- T09I- T20I- T25I- T33I- T34I-													
100	33													
125	36													
150	39													
200	42							42						
250	45	45	45	45				45						
300	48	48	48	48			48	48						
400	51	51	51	51			51	51	51	51				
500		54	54	54	54	54	54	54	54	54				
600		57	57	57	57	57	57	57	57	57				
750		60	60	60	60	60	60	60	60	60	60		60	
800		63	63	63	63	63	63	63	63	63	63	63	63	63
1000		66	66	66	66	66	66	66	66	66	66	66	66	66
1200			69	69	69			69	69	69		69	69	69
1500			72	72	72			72	72	72		72	72	72
2000			75	75	75			75	75	75	75	75	75	75
2500			78	78	78			78	78	78		78	78	78
3000			81	81	81			81	81	81		81	81	81
4000					84					84		84	84	84
5000					87					87		87	87	87
6000										90				

РАЗЪЕМНЫЙ СЕРДЕЧНИК / СМОЛА
SPLIT CORE / RESIN

Модели	TA30R	TA60R	TA80R	TA100R	TA125R	TA160R
Первичная обмотка	30x20 60x30 80x50 100x80 125x80 160x80					
Ipn (A)/pág.	20 30 50 80 80 80					
КОДЫ	T03J- T06J- T08J- T10J- T12J- T16J-					
33						
36						
39						
42						
45	45	45	45	45		
48	48	48	48	48		
51	51	51	51	51		
54	54	54	54	54	54	
57	57	57	57	57	57	
60	60	60	60	60	60	60
63	63	63	63	63	63	63
66	66	66	66	66	66	66
69	69	69	69	69	69	69
72	72	72	72	72	72	72
75	75	75	75	75	75	75
78	78	78	78	78	78	78
81	81	81	81	81	81	81
84	84	84	84	84	84	84
87	87	87	87	87	87	87



РЕЛЕЙНАЯ ЗАЩИТА / ПЛАСТИКОВЫЙ КОРПУС
PROTECTION / PLASTIC CASE

Модели	Перв. обм.	30x10	60x10	80x30	100x20	100x30	100x60
●	W _{prim.}	25	51	65	20	30	60
Ирп (А)/рэг.		10	10	10	10	10	10
КОДЫ ▶	T03P- T26P- T28P- T29P- T11P- T12P- T13P-						
50	24						
60	27						
75	30						
100	33						
125	36						
150	39						
200		42	42	42			
250		45	45	45			
300		48	48	48			
400			51	51			
500			54	54			
600			57	57			
750			60	60			
800			63	63			
1000			66	66			
1200			69	69			
1500			72	72			
2000			75	75	75		
2500					78	78	
3000						81	81
4000							84
5000							87

СЧЕТЧИК
COUNTERS

Модели	Перв. обм.	100x20
●	W _{prim.}	20
Ирп (А)/рэг.		5
КОДЫ ▶	T14S- T17S-	
24		
27		
30		
33		
36		
39		
42		
45		
48		
51		
54		
57		
60		
63		
66		
69		
72		
75		

РЕЛЕЙНАЯ ЗАЩИТА / ЗАЛИТЫЙ СМОЛОЙ
PROTECTION / RESIN

Модели	Первичная обмотка	80x20	100x20	100x60	100x95	-	-	-	-
●	Wound primary	20	20	60	95	60	80	100	125
Ирп (А)/рэг.		11	11	11	11	11	12	12	12
КОДЫ ▶	T35P- T16P- T30P- T17P- T18P- T19P- T30P- T17P- T18P- T19P-								
24									
27									
30									
33							33		
36									
39							39		
42							42		
45							45	45	
48							48	48	
51							51	51	
54	54	54					54	54	54
57	57	57					57	57	57
60	60	60	60				60	60	60
63	63	63	63				63	63	63
66		66	66	66			66	66	66
69			69	69			69	69	69
72			72	72			72	72	72
75			75	75			75	75	75
				78				78	78
					81	81		81	81
						84		84	84
							87	87	87

ТРАНСФОРМАТОРЫ – ПРЕОБРАЗОВАТЕЛИ
TRANSFORMERS - TRADUCERS

Модели	40x10	60x10	80x30	20x5	30x10	40x10
●	30	51	65	16	22	30
Ирп (А)/рэг.	13	13	13	13	13	13
КОДЫ ▶	T25N- T28N- T29N- T23Q- T24Q- T25Q-					
Первичная						
50	24					
60	27					
75	30					
100	33					
125	36					
150	39					
200	42					
250	45					
300	48					
400	51	51	51			
500		54	54			
600		57	57			
750		60	60			
800		63	63			
1000		66	66			
1200		69	69			
1500		72	72			
2000		75	75			
2500			78			
10; 12,5; 15 ó 20				12		
20; 25; 30 ó 40				21	21	
50; 60; 75 ó 100				33	33	33
125; 150; 200 ó 250				45	45	45
300; 400; 500 ó 600				57	57	

СУММИРОВАНИЕ
SUMMATION

Модели	TRS
Ирп (А)/рэг.	14
КОДЫ ▶	T02C-
Первичная	
5+5/5	10
5+5+5/5	20
5+5+5+5/5	30
5+5+5+5+5/5	40
220/110	
380/100	
380/110	
380/220	
440/100	
440/110	
440/220	

НАПРЯЖЕНИЕ
VOLTAGE

TE15R	
Ирп (А)/рэг.	14
КОДЫ ▶	T20E-
Первичная	
5+5/5	
5+5+5/5	
5+5+5+5/5	
5+5+5+5+5/5	
220/110	10
380/100	30
380/110	40
380/220	50
440/100	60
440/110	70
440/220	80

ООО "Триумф-Инжиниринг"
117105, г. Москва, Варшавское шоссе, 17
Tel.: +7 (495) 587-04-23
www.saci-rus.ru
info@triumph.engineering

S.A. DE CONSTRUCCIONES INDUSTRIALES

La Granja, 84. 28108 Alcobendas - Madrid - España
Tel.: (+34) - 91 - 519 02 45. Fax: (+34) - 91 - 416 96 46
<http://www.saci.es>
e-mail: saci@saci.es

