

# DELTA smart

## USER MANUAL



Manufacturer:



**MRU · Messgeräte für Rauchgase  
und Umweltschutz GmbH**

Fuchshalde 8 + 12

74172 Neckarsulm-Obereisesheim

Fon 07132 99620 · Fax 07132 996220

info@mru.de · www.mru.eu

Legal notices / Intellectual property rights comments

Original user manual

© 2023 by MRU

No part of this manual may be published in any form (print, photocopy, electronic media or any other publication form) without a written approval by the publisher.

All user trade marks and name mark descriptions, even those which are not marked as such, are properties of the respective owners.

Edition: 2023-04-17, V3.30.EN

**Table of content**

|          |   |           |
|----------|---|-----------|
| <b>1</b> | <b>Information for product and safety</b>           | <b>5</b>  |
| 1.1.     | Safety manual                                       | 5         |
| 1.2.     | Safety precautions                                  | 5         |
| 1.3.     | Ensure safety                                       | 6         |
| 1.4.     | Analyzer details                                    | 6         |
| 1.5.     | Lithium-Ion battery user guidelines                 | 7         |
| <b>2</b> | <b>Introduction</b>                                 | <b>8</b>  |
| 2.1.     | Intended use  | 8         |
| 2.2.     | The _Company MRU GmbH                               | 9         |
| 2.3.     | Packaging   | 10        |
| 2.4.     | Return of hazardous material                        | 10        |
| 2.5.     | Return of electronic equipment                      | 10        |
| <b>3</b> | <b>Description</b>                                  | <b>11</b> |
| 3.1.     | Gas schematics diagram                              | 11        |
| 3.2.     | The Analyzer  | 12        |
| 3.3.     | The condensate separator (water trap)               | 13        |
| 3.4.     | Extraction probes                                   | 14        |
| <b>4</b> | <b>Operation</b>                                    | <b>15</b> |
| 4.1.     | Power on and power down                             | 15        |
| 4.2.     | Function keys                                       | 15        |
| 4.3.     | Context menu  | 15        |
| 4.4.     | Combustion test                                     | 16        |
| 4.5.     | Draft / pressure measurement on combustion test     | 17        |
| 4.6.     | Display   | 19        |
| 4.7.     | Menu structure                                      | 19        |
| <b>5</b> | <b>First usage</b>                                  | <b>21</b> |
| 5.1.     | Preparatory steps                                   | 21        |
| 5.2.     | Analyzer settings                                   | 21        |
| 5.3.     | Setting time and date                               | 22        |
| 5.4.     | Measurement program configuration                   | 22        |
| 5.5.     | Set CO limits                                       | 22        |
| 5.6.     | Select fuel types and O <sub>2</sub> reference      | 23        |
| 5.7.     | Define the measuring window                         | 23        |
| 5.8.     | Define 6-lines measuring window                     | 24        |
| 5.9.     | Select and modify the Bluetooth parameters          | 24        |
| <b>6</b> | <b>Preparing measurement</b>                        | <b>26</b> |
| 6.1.     | Ensure Power supply                                 | 26        |
| 6.2.     | Automatic power down function (AUTO-off)            | 26        |
| 6.3.     | Measuring with connected charger / Battery charging | 26        |
| 6.4.     | Battery charge condition                            | 26        |

|           |   |           |
|-----------|---|-----------|
| 6.5.      | Operating temperature .....   | 26        |
| 6.6.      | Controlling condensate separator (water trap) .....                               | 27        |
| 6.7.      | Connections and tightness .....   | 27        |
| 6.8.      | Automatic zero-point setting.....   | 28        |
| <b>7</b>  | <b>Performing measurement .....</b>   | <b>29</b> |
| 7.1.      | Selecting a measurement program.....  | 29        |
| 7.2.      | Measurement screen.....   | 29        |
| 7.3.      | CO limit .....  | 29        |
| 7.4.      | Specific measuring application.....   | 29        |
| 7.5.      | Printing measurement results .....  | 30        |
| 7.6.      | Ending a measurement.....   | 30        |
| 7.7.      | Last measured values .....  | 30        |
| 7.8.      | Pressure measurements .....   | 31        |
| 7.9.      | Temperature / differential temperature measurement .....                          | 31        |
| 7.10.     | CO Ambient air.....   | 31        |
| 7.11.     | After each measurement.....   | 32        |
| <b>8</b>  | <b>Data Storage .....</b>   | <b>33</b> |
| 8.1.      | Organizing data storage .....   | 33        |
| 8.2.      | Data storage information .....  | 33        |
| 8.3.      | Sites administration .....  | 33        |
| 8.4.      | Data transfer using the SD card .....   | 34        |
| 8.5.      | Measurements in Data storage .....  | 36        |
| 8.6.      | Data transfer to the PC (Sweeping district management programmes).....            | 37        |
| <b>9</b>  | <b>Extras .....</b>   | <b>39</b> |
| 9.1.      | Service calibration menu.....   | 39        |
| 9.2.      | Factory settings .....  | 39        |
| 9.3.      | Service values.....   | 39        |
| 9.4.      | Analyzer and accessories leak test .....  | 40        |
| 9.5.      | Analyzer information, Warranty-management and analyzer identification number..... | 40        |
| <b>10</b> | <b>Maintenance .....</b>  | <b>41</b> |
| 10.1.     | Cleaning .....  | 41        |
| 10.2.     | Annual service and calibration.....   | 41        |
| <b>11</b> | <b>Appendix.....</b>  | <b>42</b> |
| 11.1.     | Technical data .....  | 42        |
| 11.2.     | Analysis and calculations .....   | 45        |
| 11.3.     | Fuel type lists.....  | 46        |
| 11.4.     | Troubleshooting.....  | 48        |
| 11.5.     | O-Ring Set for DELTAsmart .....   | 49        |

# 1 Information for product and safety

## 1.1. Safety manual

All general information and safety precautions of MRU products are listed in the supplied separate safety manual.

Therefore, this manual must be read and observed before the first use of the instrument.

## 1.2. Safety precautions

The used categories of safety precautions are here explained once more.



### **⚠ DANGER**

Describes an immediate threat of danger which can cause mayhem or can even cause death.



### **⚠ WARNING**

Describes an immediate threat of danger which can cause mayhem, property damage or can even cause death.



### **⚠ CAUTION**

Describes a possible danger that can cause risk of injury.



### **ATTENTION**

Describes a possible harmful situation which can damage the analyzer or its surroundings.



### **NOTE**

Gives user hints and other important information.

### The explanation of safety notices:



### **⚠ CAUTION**

**HOT – danger of burns and fire hazards from gas extraction probe.**

Physical harm and property damage can be caused.

► Cool down the probe tube.

### 1.3. Ensure safety

- The analyzer may only be used for its intended purpose and within its defined technical parameters. Don't use any force and avoid dropping the analyzer.
- Don't use the analyzer when there are visible damages of the enclosure, the charger or supply lines.
- Don't store the analyzer together with solvents and don't use any drying agents.
- Only perform maintenance procedures that are described in this manual and always obey the instructions.
- Only operate the analyzer in closed and dry rooms, protect the analyzer against rain and moisture.
- Only operate the analyzer with the supplied battery charger.
- Never use the probe tube and other metal parts / accessories as electric conductors.
- The analyzer may not be positioned near open fire or extreme heat.
- The defined temperature range of the extraction probe / probe tube may not be exceeded, the probe tube and/or thermo-element can be destroyed.

### 1.4. Analyzer details

- The analyzer is not suitable for long term (continuous) measurements (this is a spot analyzer).
- Before using the analyzer verify the condition of the various parts of the analyzer, such as the probe, the ambient air conditions, the condensate separator, star filter and the connectors for damage and/or blockages.
- When starting the analyzer up it will take between 1 – 3 minutes to set to zero depending on the condition of the sensors and ambient conditions. (Zeroing).
- The minimum zeroing time of the analyzer to achieve correct measurement values can be expected by 1.5 minutes!
- Exposure to acids; aggressive gases such as Sulphur; vapours such as thinners, gasoline, alcohol and paint, etc. can damage, reduce the life of, or destroy the sensors.
- The life of the sensors depends on how they are used, maintained and treated. Typical average life expectations are: O<sub>2</sub> - 2 years; CO - 2 - 3 years and NO - 3 years.
- The battery life is at least 500 charge-discharge cycles. With increasing number of charging cycles the battery capacity (indicated in operating hours) is reduced.

## 1.5. Lithium-Ion battery user guidelines

### NOTE



The battery is inside the analyzer and is not accessible to the end-user.

Below are some guidelines you need to know about Lithium Ion batteries and the handling of these.

- The rechargeable battery may only be used for this **DELTA**smart analyzer.
- Don't charge the analyzer in extreme heat, don't store the battery in a hot environment and don't throw the battery into fire.
- Don't try to modify the battery, shortcut it or put any mechanical force to it!
- The battery may not be used in or under water.
- Avoid mechanical force and don't throw that battery.
- Don't cut or squeeze the battery cables!
- Don't carry or store the battery together with sharp objects.
- Don't connect the (+) contact with the (-) contact or connect these to a metal object.
- Not obeying the above instructions can cause heat, fire and explosion.

## 2 Introduction

- This manual enables you to understand and safely operate this **DELTA**smart combustion analyzer. Please read this manual with great vigilance and get familiar with the product before using it.
- This analyzer may only be operated by competent personnel and for its intended use.
- Please pay special attention to all safety directions and warnings to prevent personal injuries and damaging of the product.
- We can't be held responsible for any injuries and/or damages that occur by not following the instructions in this manual.
- Always keep the manual near you when working with the analyzer, to be able to read instructions as needed. Please ensure to hand over all documents to when handing the analyzer over to others.

### 2.1. Intended use

The **DELTA**smart analyzer is intended for short-term measurement in the context of emission control measurements and adjustments at small furnaces. The analyzer measures the measurements provided by VDI4206 and EN50379 metrics and stores them for further processing.

The **DELTA**smart analyzer is specifically not intended as a safety device or personal protective equipment; it should not be used as a warning device to warn people against the presence of harmful gases.

The **DELTA**smart analyzer may only be used as indicated in this manual. Our analyzers are checked according to the following regulations: VDE 0411 (EN61010) and DIN VDE 0701 before they leave the MRU GmbH factory. MRU technical products are designed and manufactured according to DIN 31000/ VDE 1000 and UVV = VBG 4 of the professional guilds for fine mechanics and electrical engineering. MRU GmbH assures that the analyzer complies to the essential requirements of the legal regulations of the member states of the electro-magnetic compatibility (2014/30/EU).

#### **WARNING**



#### **Risk from manipulations to the measuring device**

Operational safety hazard

- Modifications or changes to the measuring device are not allowed.

## 2.2. The \_Company MRU GmbH

The **DELTA**smart analyzer is manufactured by the MRU GmbH in Neckarsulm Germany (founded in 1984), a medium sized company that specializes in developing, producing and marketing high quality emission monitoring analyzers. MRU GmbH produces a wide range of instruments, from standard analyzers up to tailor made industrial analyzers. MRU GmbH contact details are listed on the previous page.



Plant 1: Sales, Service, R&D



Plant 2: Production

MRU GmbH  
Fuchshalde 8 + 12  
74172 Neckarsulm - Obereisesheim  
GERMANY  
Phone +49 71 32 99 62 0 (Front office)  
Phone +49 71 32 99 62 61 (Service)  
Fax +49 71 32 99 62 20  
Email: [info@mru.de](mailto:info@mru.de)  
Internet: [www.mru.eu](http://www.mru.eu)

### **2.3. Packaging**

Please keep and store the packaging material to be able to use it when your analyzer must be sent back for service and calibration.

### **2.4. Return of hazardous material**

Waste Disposal>Returns/Warranty - MRU GmbH is required to accept the return of hazardous waste such as electro-chemical sensors that cannot be disposed of locally.

Hazardous waste must be returned to MRU prepaid.

### **2.5. Return of electronic equipment**

MRU GmbH is required to accept the return, for proper disposal, of all analyzers delivered after 13<sup>th</sup> of August 2005.

Analyzers must be returned to MRU prepaid.

### 3 Description

The main task of the **DELTA**smart analyzer is to assist with precision control and adjustment measurements of gas, oil and wood fired furnaces. Available options for this and other analyzers can be found on the MRU Homepage or speak to a member of our sales team.

#### 3.1. Gas schematics diagram

In combination with the extraction probe (inserted in the stack) the internal gas pump of the **DELTA**smart analyzer extracts a portion of the flue gas and analyzes it using electro-chemical sensors.

The thermo-element in the probe tube measures the flue gas temperature and due to the construction of the probe pressure (draft) can be measured as well.

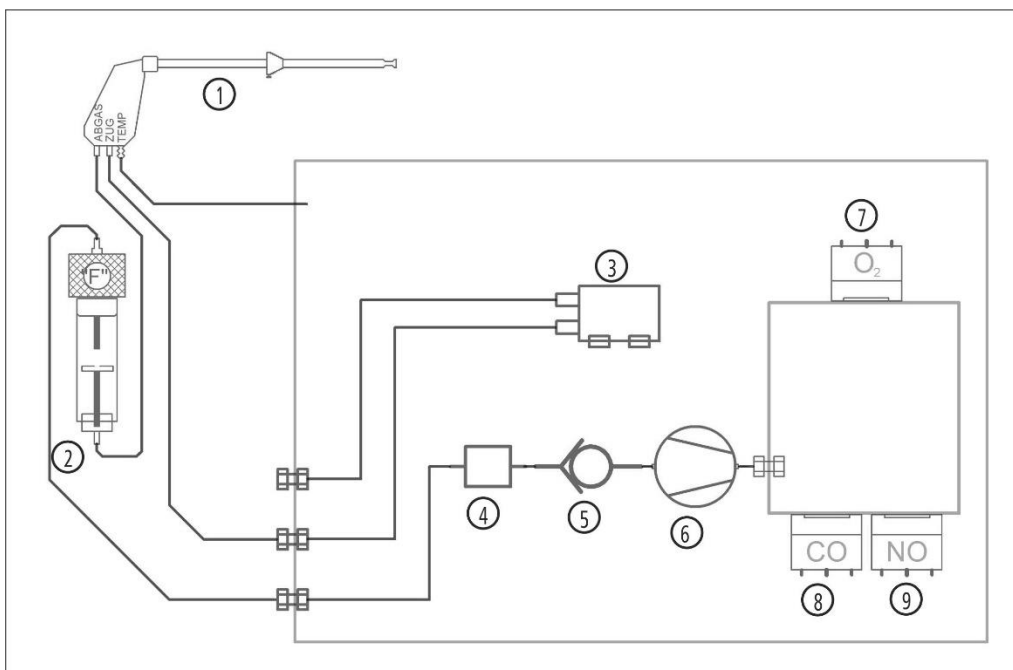

|   |                                   |
|---|-----------------------------------|
| 1 | Extraction probe                  |
| 2 | Condensate separator (water trap) |
| 3 | Draft/pressure sensor             |
| 4 | Internal filter                   |
| 5 | Non return valve                  |
| 6 | Gas pump                          |
| 7 | O <sub>2</sub> sensor             |
| 8 | CO-sensor                         |
| 9 | NO-sensor (optional)              |

### 3.2. The Analyzer

The compact analyzer is made from a fiber re-enforced plastic material with all measurement related connections at the bottom of the analyzer. The analyzer is operated exclusively using the touch screen display.



|    |   |
|----|---|
| 1  | Touch screen display  |
| 2  | Connection port P2 for draft measurement                        |
| 3  | Temperature port T2 for gas temperature                         |
| 4  | Connection port P1 (only for differential pressure measurement) |
| 5  | Temperature port T1 for ambient air temperature                 |
| 6  | Connection port flue gas entrance                               |
| 7  | Gas exit (may not be covered during operation)                  |
| 8  | Mini USB port for battery charging and data transfer            |
| 9  | Reset button  |
| 10 | IR interface for external IR printer                            |
| 11 | Micro-SD-card slot  |

### 3.3. The condensate separator (water trap)

During a measurement condensate is being collected in the condensate separator. The maximum water level is marked with a ring on the bottom part of the show glass.

Empty the condensate separator frequently to avoid water getting into the analyzer.

☞ See also chapter 6.6 Controlling condensate separator (water trap), Page 27.

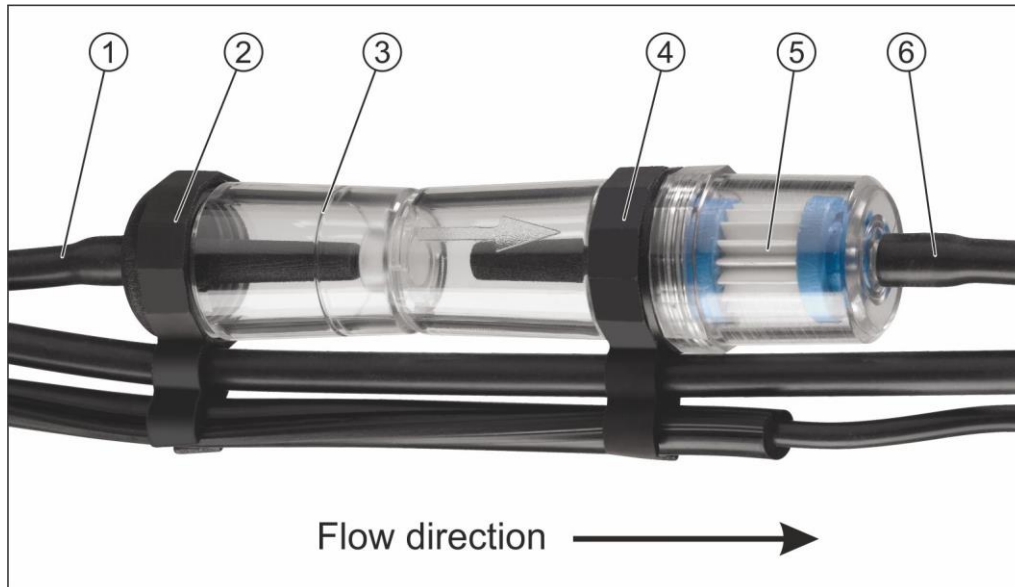

|   |   |
|---|---|
| 1 | Hose connection from probe sampling line      |
| 2 | Bottom hose connector                         |
| 3 | Condensate show glass with max fill indicator |
| 4 | Top connection                                |
| 5 | Star filter and filter housing                |
| 6 | Hose connection to analyzer                   |

### 3.4. Extraction probes

The **DELTA**smart is available with either a probe with fixed probe tube or with exchangeable probe tubes. A complete list of available probe options can be found in our effective price list.

Here are 2 possible options:

#### **Extraction probe**

With 250 mm fixed probe tube and 1,5 m sampling line

#### **Extraction probe**

With 180 or 300 mm exchangeable probe tube and 1,5 m sampling line

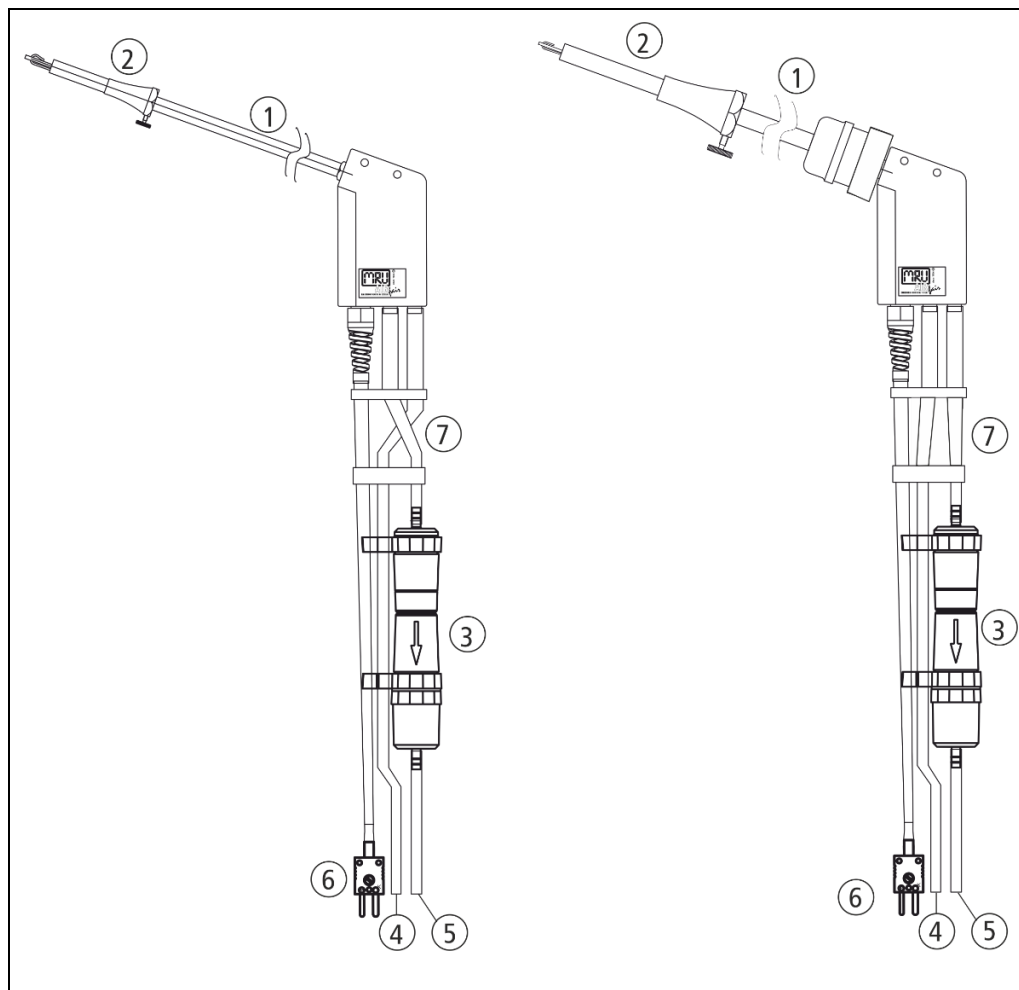

|   |                                  |
|---|----------------------------------|
| 1 | Probe tube                       |
| 2 | Probe cone                       |
| 3 | Condensate separator             |
| 4 | Hose for draft measurement       |
| 5 | Hose for flue gas measurement    |
| 6 | Plug for temperature measurement |
| 7 | Triple hose                      |

## 4 Operation

### 4.1. Power on and power down

The DELTAsmart is powered on using the display.

Touch the screen and the green **ON** button will appear, then press the **ON** button to power on the analyzer.



Use the **context menu** button to power the analyzer down.

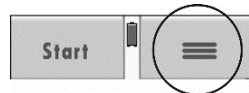

Now press the red **OFF** button to power the analyzer down.

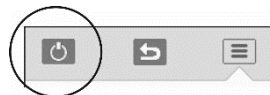

Once the analyzer has been started it will make a self-test and then perform the zeroing of the analyzer. It is important that at this point the analyzer is operated at ambient air and that the pressure ports are without pressure.

### 4.2. Function keys

In all operation windows there are pre-defined function keys at the top and the bottom of the screen.

At the top of the screen these are mostly the **return** key and the **context menu** key.

At the bottom of the screen these are mostly the **page up** and **page down** keys.

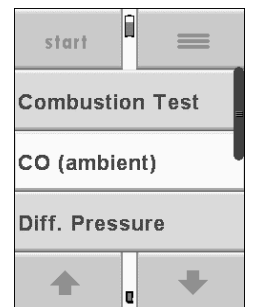

Dependent on the page that you are currently on, the function keys can have different functions to allow faster access.

### 4.3. Context menu

The **context menu**-button offers additional functions. When pressing the **context** key, you will see a variety of functions related to the window that you are currently in.

There are also general functions like: switch off analyzer, exit window, close context menu without action.



|   |   |
|---|---|
| 1 | Power analyzer down                     |
| 2 | Return – exit window                    |
| 3 | exit context menu window without action |

#### 4.4. Combustion test

### ⚠ DANGER



#### Poisonous gas can be present

The possibility of death through intoxication.

Flue gases are extracted by the analyzer and then evacuated into the ambient air.

- ▶ Only operate the analyzer in well ventilated rooms.

### NOTE

#### Wrong measuring results



The extracted flue gas must be able to evacuate the analyzer without obstruction.

- ▶ The exhaust outlet at the rear of the analyzer may never be covered during a measurement, never operate the analyzer in a transport case.

Start: starts a combustion test with the current selected program and fuel type.

Press **Combustion test**, then select one of the 4 **programs** and then select the **fuel type**.

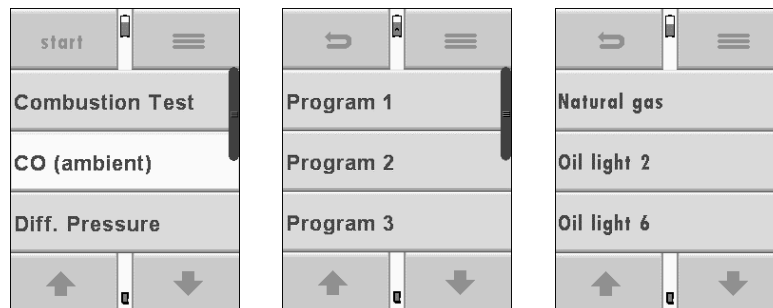

The measurements window has in total 20 measurement parameters, 4 parameters each on 5 pages. There are 2 ways to move from page to page:

- Press the context key and then select page + or page -,
- Or simply touch the left or right border of the display to jump to the next or previous page

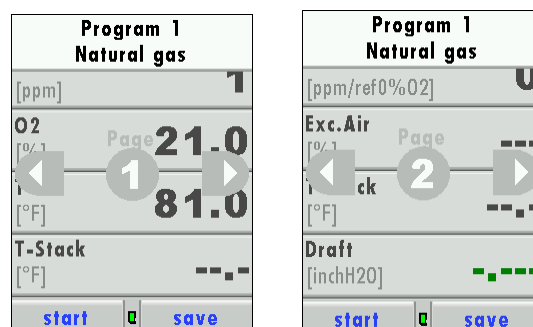

|   |                            |
|---|----------------------------|
| 1 | Info (Program / Fuel type) |
| 2 | Page 2                     |

#### 4.5. Draft / pressure measurement on combustion test

The draft is measured using the DELTAsmart in combination with the extraction probe either before or after gas measurement.

While inside the measurement window you press the context menu key and then select the draft/pressure key. During this phase the gas pump stops working, and gas measurement values are frozen.

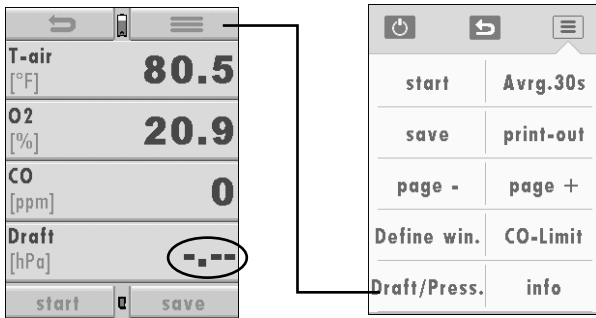

In the draft/pressure screen the measured values will be displayed. These values can be carried over as either draft or pressure value into the gas measurement screen. (The difference between these 2 values are basically the pre-sign and name before the value – a draft in the stack will be displayed as positive draft)

#### NOTE

##### To avoid false readings



The position of the analyzer during pressure sensor zeroing is important.

- ▶ During zeroing the analyzer should be in the measurement position.

With the return key you switch back to the gas measurement and the measured draft value will be visible (unmodifiable) in a different color.

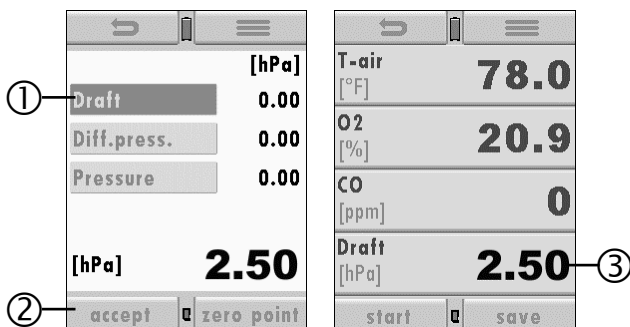

|   |   |
|---|---|
| 1 | Select pressure type  |
| 2 | Accept  |
| 3 | Accepted value has been transferred to the measurement screen |

### Connection for draft measurement

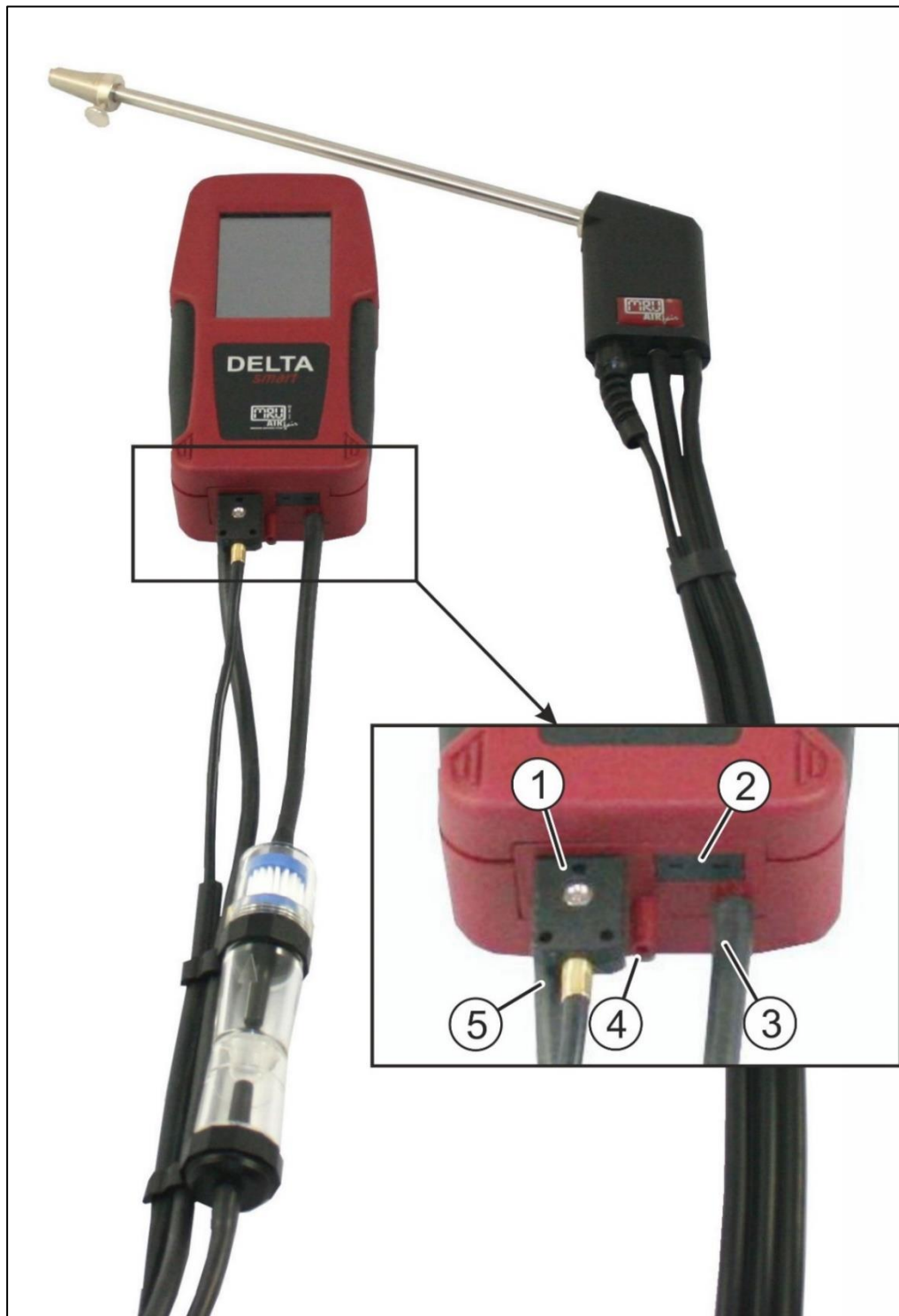

|   |   |
|---|---|
| 1 | Temperature port T2 for gas temperature             |
| 2 | Temperature port T1 for ambient air temperature     |
| 3 | Connection port flue gas entrance                   |
| 4 | Connection port P1 (not used for draft measurement) |
| 5 | Connection port P2 for draft measurement            |

#### 4.6. Display

All information needed to operate the analyzer are displayed on the screen:

|   |   |
|---|---|
| 1 | Main menu lines   |
| 2 | Function keys   |
| 3 | Function keys e.g. page up/down   |
| 4 | Zeroing status bar  |
| 5 | Charging status of the battery  |
| 6 | SD-card in the SD card slot Indication green - Read and write access Indication yellow - only Read access (SD-Card write protected) |
| 7 | Scroll bar for main menu lines  |

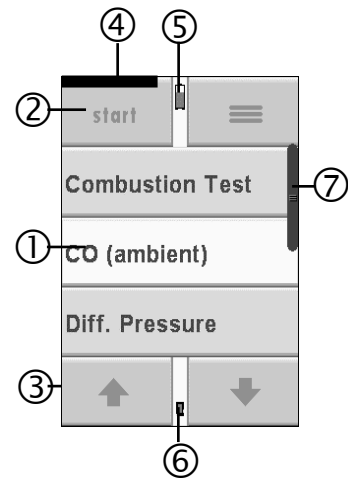

#### 4.7. Menu structure

The **DELTA**smart has all available functions available in 3 main menus: Measurement, Storage and Extras.

From each of the above-mentioned menus one can switch over to the next or previous menu by using the context key and then select the menu you want to go to

|                          |  |
|--------------------------|--|
| <b>Measurement</b> menu: | Here are all measurement related functions available. All installed and available measurement options can be selected here.      |
| <b>Storage</b> menu:     | Here all storage related functions are available like site administration, data memory, data transfer and so on.                 |
| <b>Extras</b> menu:      | Here are all administration related functions available. Analyzer settings, date and time, service menu, device info and others. |

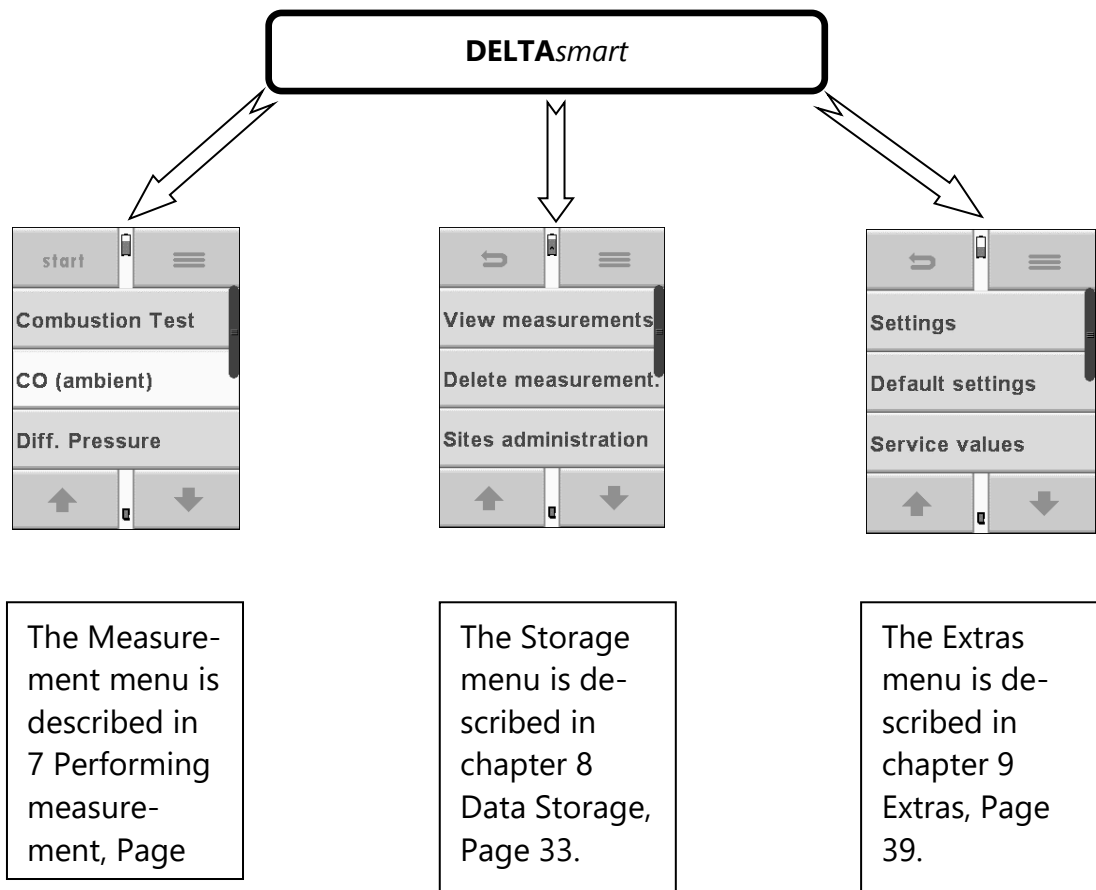

## 5 First usage

Once you have determined that the analyzer is safe to be used, it can now be customized to meet your needs, these modifications can be changed at any time.

### 5.1. Preparatory steps

- Remove the analyzer from its packaging and read the complete manual.
- The analyzer has left the manufacturer completely assembled and ready to use. Check if everything indicated has been delivered and that there are no visible damages.
- Charge the battery for at least 8 hours.
- Check and modify date and time if needed.

### 5.2. Analyzer settings

In the main menu **Extras** and sub menu **Settings** the following modifications can be made:

- LCD brightness
- Language
- Country for country specific fuel types and measuring functions
- Helping hints (on/off)
- Keyboard beep (on/off)
- Temperature units

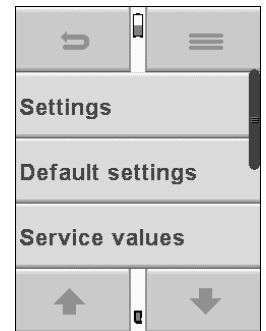

|                   |           |  |
|-------------------|-----------|--|
| Country           | Option    |  <p>By changing the country, the O2 reference values will be lost. The fuel type lists are reset. Country specific parameters will be activated. Please check if all the country specific parameters are correct, to assure that the analyzer meets the regulations for the country that you are using this analyzer in</p> |
| Language          | Option    | Select the analyzer language   |
| LCD brightness    | 5 – 100 % | The display-contrast is dependent on ambient temperatures as well as the user's perspective, at 20°C +/- 50% is normal   |
| Keyboard beep     | ON/OFF    | Turn on / off the keyboard beep  |
| 6-lines           | ON/OFF    | Turn on / off 6-lines measuring window   |
| Helping hints     | ON/OFF    | Turn on / off helpful hints  |
| Temperature units | °C or °F  | Select the temperature unit  |

### 5.3. Setting time and date

In the main menu **Extras** and sub menu **Date & time** date and time can be viewed and modified. The analyzer changes the time automatically between standard time and daylight savings time.

The time and date must be modified in case the battery has been discharged completely.

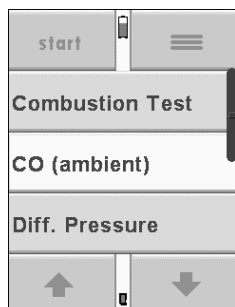

### 5.4. Measurement program configuration

There are 4 programs available for gas measurement. The programs define the following parameters:

- A selection of fuel types: a selection of the maximal fuel type list
- Measurement window: define 4 measurement values per page on 5 pages in total
- Program name

Pre-defined measurement programs are

- Combustion test
- CO (ambient)
- Combustion test – sub menu **Test program**

This is used to check the analyzer with test gases without the selection of a fuel type (third party testing)

Modifications of these programs can be made once a program has been selected and then use the CONTEXT key to select modifiable options.

### 5.5. Set CO limits

High CO concentrations in the gas stream can shorten the life span of your CO sensor. The **DELTA**smart can warn the user if the analyzer exceeds a pre-defined CO limit. There will be both an acoustic and visual signal, the

**DELTA**smart has **NO** active CO overload protection! In case the pre-defined CO limit is active you will have to remove the probe from the stack or you take actions to lower the CO values.

The CO limit can be defined for each of the 4 measurement programs. Using during the measuring the context menu and you can press the CO limit key – the CO limit can be changed in 100 ppm steps.

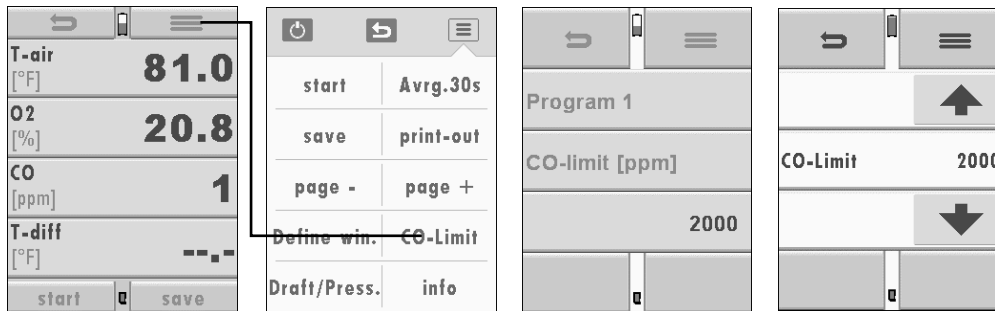

### 5.6. Select fuel types and O<sub>2</sub> reference

After selecting a measurement program, you can select or add fuel types. You can define what fuel types you want to see for each measurement program by using the fuel type list.

Select the **context menu** key and then select **fuel type list**.

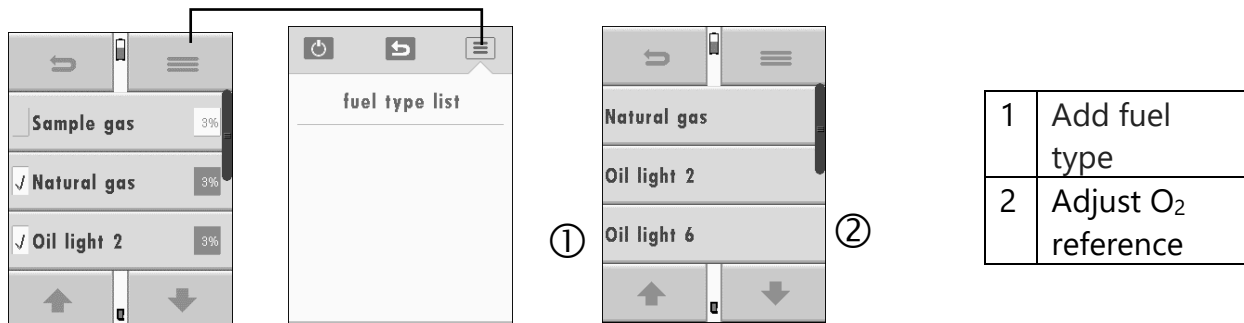



|   |  |
|---|--|
| <b>NOTE</b>   |  |
|  | <p>Note that it is not possible to add fuel types manually. If necessary, an additional country setting can be purchased at a later date.</p> <p>Please contact the manufacturer for this.</p> |

### 5.7. Define the measuring window

The DELTAsmart can display 20 measurement values – 4 values on 5 pages. The user can define in what order he wants to see the available measurement values.

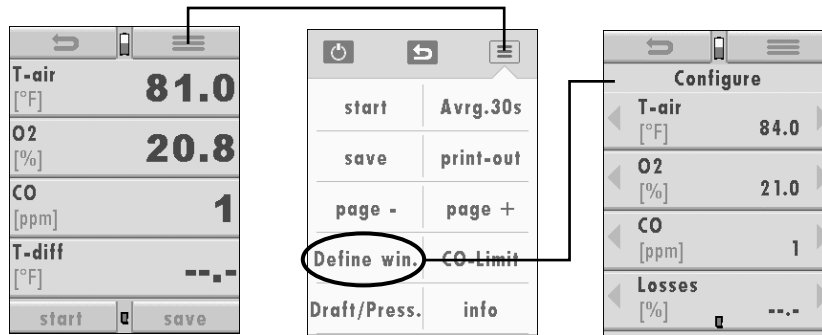
Please select **MEASURING WINDOW– CONTEXT MENU – DEFINE WINDOW**. You will then select the line that needs to be modified and with left and/or right you can view and select available parameters. This procedure will be done for each line.



When completed you will exit this window using the  button.

### 5.8. Define 6-lines measuring window

In the main menu, Extras you can select the 6-lines measuring window:

:

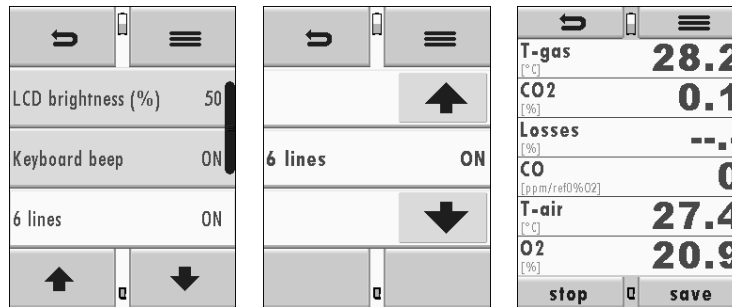

The **DELTA**smart can display 18 measurement values – 6 values on 3 pages.

### 5.9. Select and modify the Bluetooth parameters

Depending on the equipment, the analyser can be used to exchange measurement data with external devices via Bluetooth:

- With MRU4u (App for Android and iOs smartphones)
- With MRU4Win
- With MRU Bluetooth printer

Depending on the software version of the analyser and the technical specification of the Bluetooth interface, settings for data transmission may be required. Please check in the following menu:

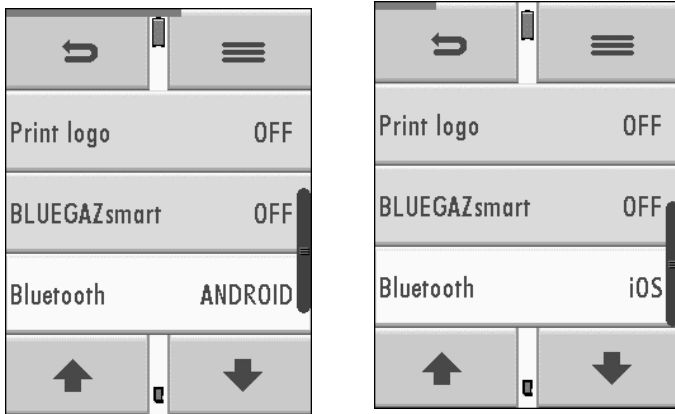

Adjustments can be made in the main menu **EXTRAS** / sub menu **Settings** / sub menu **Bluetooth**.

If the settings window appears as shown above, please select whether you are connected to an Android or iOS smartphone. You realise a connection to the Bluetooth printer or to MRU4WIn with the setting "ANDROID".

The Bluetooth-Passkey (connecting code) is: 1234

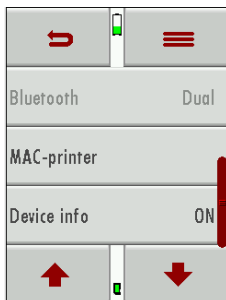

If "DUAL" appears in the settings window instead of the selection ANDROID and iOS, the Bluetooth module supports all applications without further settings.

## 6 Preparing measurement

### 6.1. Ensure Power supply

The **DELTA**smart can either be used with:

- Internal battery (included with analyzer delivery)
- Battery charger (included with analyzer delivery)

Connect external accessories only when the analyzer is switched off!



### 6.2. Automatic power down function (AUTO-off)

The analyzer switches off automatically if is in one of the 3 main menus and no key has been pushed for 60 minutes.

During measurement and analyzer charging (USB port) the Auto-off function is deactivated.

Before shutting down, the analyzer will display it's intend of shutting down, which you can prevent by pressing any key on the display.

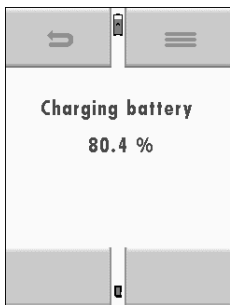

### 6.3. Measuring with connected charger / Battery charging

The analyzer will be charged when you connect the external USB charger 90..260 V / 50/ 60Hz.

During battery charging the analyzer can be operated and be used for measurements.

Once the battery is fully charged, the analyzer will switch to trickle charge mode.

### 6.4. Battery charge condition

The battery symbol on the display indicates the remaining capacity of the battery. About 15 minutes (dependent on analyzer configuration) the battery symbol will flash red in 1 second intervals. When the battery is almost drained, and the analyzers is not connected to the external charger, the analyzer will power off to prevent damage to the battery.

### 6.5. Operating temperature

In case the analyzer has been stored under cold or very cold conditions, you must give the analyzer time to adjust to the warmer environment before switching it on, to prevent condensation inside the analyzer! The analyzer will display a message in case it is outside of its operation range.

In this case the **DELTA**smart is not operational and will send an acoustic signal while warming up.

## 6.6. Controlling condensate separator (water trap)

The condensate separator must be emptied before and after each measurement, you will get a reminder to do that when switching off the analyzer.

The condensate separator must be checked before, during and after each measurement.

Check if the condensate separator is **empty** and if the pleated filter is white (clean).

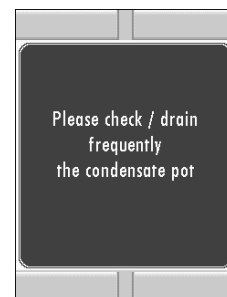

### ⚠ CAUTION



#### Condensate is acidic

The condensate from the container can be slight acidic and can cause chemical burn.

- ▶ Immediately clean with plenty of water once you have encountered acid

Here is how to empty the condensate separator:

- Move the hoses from the upper bracket to the side.
- Unscrew upper plug (counter clock wise) then lift it.
- Empty the container with caution.
- The condensate separator can easily be disassembled / assembled to remove the filter and to let the condensate separator dry.
- Both plugs have gaskets, which must be present, undamaged and in the correct position when you assemble the condensate separator again.



## 6.7. Connections and tightness

- Check if all connections are connected properly.
- Check the complete probe, sampling line and condensate separator for leaks / leak tightness.

The **DELTA**smart offers an automated test to check if the complete system is leak tight.

☞ See also Chapter 9.4 Analyzer and accessories leak test, Page 40.



### **6.8. Automatic zero-point setting**

Touch the display then press the green ON button. The analyzer will perform a self-check and start zeroing.

During zeroing the probe must be in ambient air (not in the stack)!

During zeroing there is a blue zeroing bar (top of display) visible.

Once zeroing is completed, the blue bar will disappear and the

**DELTA**smart is ready for measurement.

The analyzer will display a defect sensor if any of the installed sensors is not ready after zeroing.

#### **Repeating the zeroing**

Zeroing can be repeated at any time as long as the probe is not inside the stack and at ambient air. In the main menu „Measurement“ you select the „zeroing“ button.

## 7 Performing measurement

In the base configuration each DELTAsmart has the capability to perform a combustion test. Here is a complete description how to perform a combustion test.

Once powered up the analyzer is in the measurement menu.

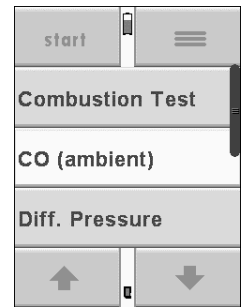

### 7.1. Selecting a measurement program

Select „Combustion Test“ then select 1 of the 4 pre-defined measurement programs.

OR – press the „Start-Button“ and you will use the last used measurement program (skip program and fuel type selection).

### 7.2. Measurement screen

The measurement values are on 5 pages with 4 values on each page as described in chapter 4.4.

Measurement values are available as direct measured like O2 and temperature, as well as calculated values like CO2 and efficiency. Some values are available with different parameters like CO in ppm or CO in mg/kWh.

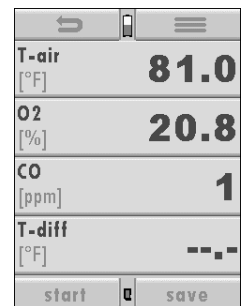

Not available values will be displayed with dashes. Reasons for not available values are:

- A sensor has been recognized as defect during zeroing.
- External temperature sensors are not connected.

### 7.3. CO limit

The CO value on the screen will turn red once the CO limit has been reached.

The CO limit is adjustable, please read chapter 4.5 for information.

### 7.4. Specific measuring application

#### Test program

This program is used to test the analyzer with test gases (3<sup>rd</sup> party testing).

Only measured parameters will be displayed (not calculated values).

The CO limit will not trigger an alarm.

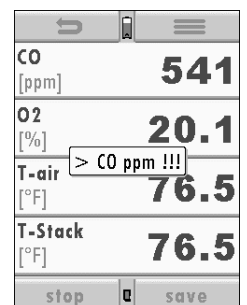

## 7.5. Printing measurement results

The measuring results can be printed from each measuring program using the printer button in **MEASUREMENT SCREEN / CONTEXT MENU (print-out)**. The values will be printed the same way the screen is defined; double values will only be printed once.

In menu **Extras/Settings** you can define the number of site lines for printing

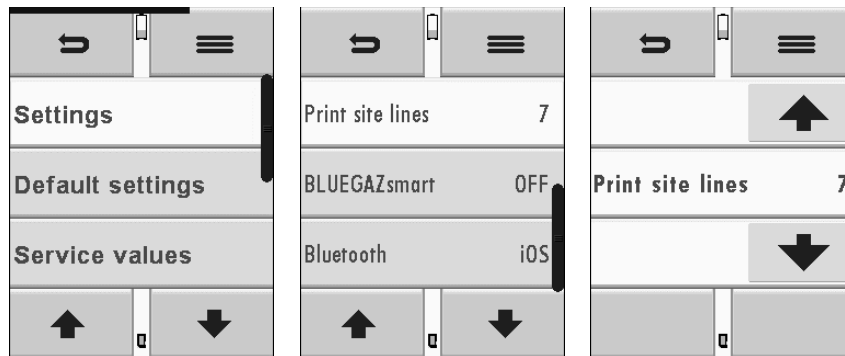

With the printout, you get the defined number of lines e.g. city, address etc.

## 7.6. Ending a measurement

A measurement can be stopped at any time using the Stop-Button. The window changes its color and the values are frozen. All values that had been present when the measurement was stopped can still be viewed. With the Return button you return to the main menu „Measurement“.

## 7.7. Last measured values

The DELTA<sup>smart</sup> offers the possibility to display the last measured values even if they have not been stored inside the analyzer. In the main menu you select „last measured values“. You can view the values, print them or store them. These values are erased once you power down the analyzer.

### 7.8. Pressure measurements

In the pressure measurement menu, 4 pressure values can be recorded. A measured value can be saved to dedicated place (e.g. Pressure 1) these adjustments are made in the context menu. For draft measurements you use the probe having the hose connected at + port of the analyzer. For differential pressure a second hose will be connected to the Delta P- port of the analyzer.

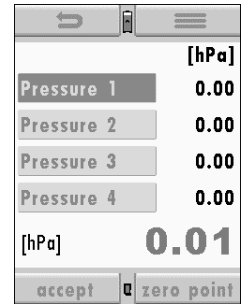

#### ATTENTION



#### Analyzer can be damaged by faulty operation

The pressure sensor can be damaged or destroyed when the supplied pressure is too high.

- ▶ Check the pressure sensor range before applying pressure.

### 7.9. Temperature / differential temperature measurement

In the menu temperature differential measurement 2 temperatures can be measured. Both measured values will be displayed (using port T1 and T2) as well as the difference of these values will be displayed.

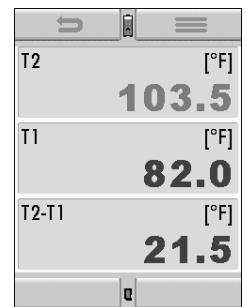

#### NOTE

The accuracy of this measurement can only be warranted when MRU temperature sensors are used..

### 7.10. CO Ambient air

In some countries the use of the CO Ambient program is mandatory. The purpose of this program is to determine CO concentrations near of the measurement port.

**The CO ambient menu will be displayed in the main menu only in combination with pre-selected countries.**

The zeroing of the CO ambient test must always be performed at ambient air (fresh air) and before each measurement, preferable outside the building or boiler room.

Start the CO Ambient test at ambient air.

The actual CO value will be displayed. (This value should be close to 0 ppm!)

The current CO (AMBIENT) value and the CO (PEAK) value will be displayed.

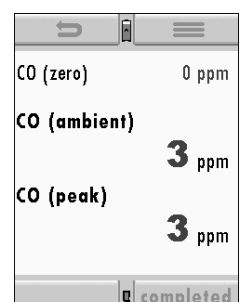
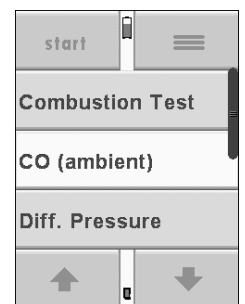

### 7.11. After each measurement

Once a combustion test has been completed the probe is removed from the stack and the hole in the stack (flue gas pipe) must be closed with an appropriate sticker (tape).

#### **▲ CAUTION**



**HOT – danger of burns and fire hazards from gas extraction probe.**

Physical harm and property damage can be caused.

- ▶ Cool down the probe tube.

#### **ATTENTION**



**Thermo-element can be damaged**

The thermo-element at the tip of the probe tube is very delicate and can easily be damaged.

- ▶ Once the probe has cooled off slide the probe cone to the tip of the probe tube and fixate it to protect the thermos-element.

## 8 Data Storage

### 8.1. Organizing data storage

The basis for the data storage of the **DELTA**smart are saved sets of sites inside the analyzer. Each site has a distinct site number as well as 8 additional free text lines for names and address.

The analyzer can store up to 1,000 different sites.

New sites can be added in the analyzer. Modifications can be done using an external PC program e.g. MRU Win.

Attention: New sites created in the analyzer will NOT be transferred back to the computer program. When transferring data from the analyzer to the computer only measurement data will be transferred, identified by the site number that has been assigned to the measurement, when the measurement was saved.

### 8.2. Data storage information

In the menu **storage** and sub menu **Memory info** the number of stored data can be viewed. Sites (max. 1,000) and Flue gas measurements (max. 3,000).

### 8.3. Sites administration

In the sub menu **Sites administration**, you can:

- View all saved sites
- Add new sites
- Delete sites
- Changes made in the analyzer will NOT be transferred to a PC program!!



#### NOTE

New sites created in the analyzer will NOT be transferred to a PC program.

#### View sites

In the sub menu **Sites administration** each site will be displayed with:

- The distinct site number in the first line, because of its significance this number is displayed in a different colour.
- Plus 8 additional free text lines.

With the arrow buttons left and right you can page from site to site.

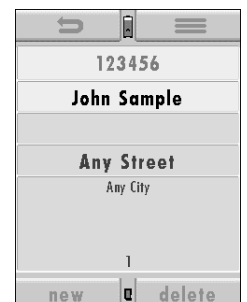
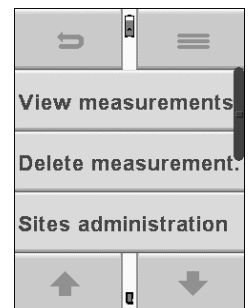
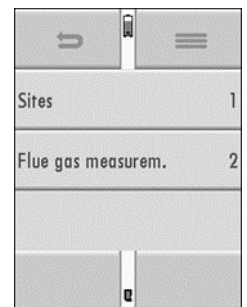
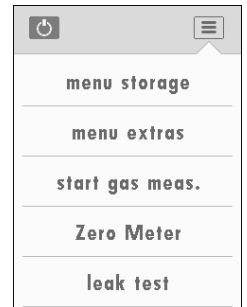

### Create a new site



In the sub menu **Sites administration** new sites can be created and existing sites can be modified.

Select **new** to create a new site. The following will be displayed:

- The first line, the distinct site number to identify the site. The analyzer will automatically select the next available site number.
- All other free text lines for e.g. name and address. (These lines can only be filled using an external PC program like the MRU Win)

### Delete sites

You can:

- In the sub menu **Sites administration** single sites can be deleted using the **delete** button.
- Or you can delete all sites at once

The pop-up window will ask you to confirm the deletion of the site (sites).

## 8.4. Data transfer using the SD card

The data exchange format is CSV. A character-separated values (CSV) file is a simple text format for a database table. Each record in the table is one line of the text file. Each field value of a record is separated from the next by a character. The analyzer uses a semi-colon ';' as value separator (other implementations use sometimes a comma). Implementations of CSV can often handle field values with embedded line breaks or separator characters by using quotation marks or escape sequences. CSV is a simple file format that is widely supported, so it is often used to move tabular data between different computer programs, for example Microsoft Excel™ or Access™, that support the format. Other computer programs offer this type of interface because it is widely spread and easy to use.

The following functions are available:

- Import of sites
- Export of sites
- Export of combustion tests

### Import of sites

With this function you can Import Sites which have been created on a computer or another Analyzer.

The File name must have the name "anlagen.csv" (anlagen = German for sites).

The file has no column heading that means that the first line already has user data. Each line has a minimum of 9 columns (with 8 commas) and the first field in the line will be the site number. All data will be imported as long a site number is available. Per field a maximum of 24 characters will be imported, too long words will be cut off.

### Example for sites

| Site                | Spelling  |
|---------------------|---|
| 9 fields            | A1-F1,A1-F2,A1-F3,A1-F4,A1-F5,A1-F6,A1-F7,A1-F8,A1-F9 |
| 2 fields (1 and. 4) | A4-F1;;;A4-F4   |
| 1 field             | A5-F1   |

### Reasons for invalid sites:

- Comma at the beginning
- Blank line

### NOTE

Whilst importing data from the SD Card to the analyzer there is no check for double site numbers (Line 1), neither inside of the file that is imported nor between the file and the sites already inside the analyzer. The analyzer can easily handle double site numbers, but you could face problems with double site numbers when exporting them again to a computer program (see also 3. + 4. Export of Measurements).



However, the analyzer marks the files that have been imported successfully. If you try to import a file with the same analyzer that is already in the analyzer you will get a red information screen.

### Export of sites

This function can be used for an analyzer back up or if you wish to supply the analyzer information to a computer program or another analyzer. This is very handy if you have made some modifications inside the analyzer (site) for example if you have modified the phone number of a customer and this modification needs to be updated in the computer software, or if a second analyzer needs to have the same site information. The File format is the same as described above „Import of Sites“. Only the file name is different, the file name will be ‚ANLxxxx.csv‘, in which the xxxxx are continuing 5-digit numbers with leading zeros. If the file must be imported into another analyzer, the file must first be renamed into „anlagen.csv“.

## Export of Combustion Tests

This function is used to export combustions tests from the analyzer to a computer program.

**Attention!** This function is not suitable for back up or for the transfer to another analyzer because the exported file cannot be imported again! The created file has the name ,EMLxxxx.csv', in which the xxxx are continuing 5-digit numbers with leading zeros.

The created file has a column header with the following information: Site number, Date/Time, measuring program name, Fuel type, CO2max, O2reference, and all measured values that the analyzer can measure as well as the soot numbers, Derivate and T-Boiler.

Example:

| Anlagen-Nr. | Datum & Uhrzeit        | Messprogramm     | Brennstoff     | CO2max [%] | O2bez. [%] | T-Gas [°C] | T-Luft [°C] | O2 [%] | Verluste [%] |
|-------------|------------------------|------------------|----------------|------------|------------|------------|-------------|--------|--------------|
| A1-Z1       | MO 15.11.2010 15:32:54 | Abgasmessung     | Erdgas BlmSchV | 11,8       | 3          | 32,7       | 26,1        | 19,1   | 2,4          |
| A1-Z1       | MO 15.11.2010 15:33:25 | CO-Messung       | Erdgas BlmSchV | 11,8       | 3          | 32,7       | 25,9        | 19,5   | 3,2          |
| A1-Z1       | MO 15.11.2010 15:33:48 | Ringspaltmessung |                | 11,8       | 3          | 29,7       | 26          | 18,7   | 1,1          |
| A2-Z1       | MO 15.11.2010 15:34:19 | Abgasmessung     | Heizöl EL      | 15,4       | 3          | 32,8       | 25,8        | 18,9   | 2,3          |

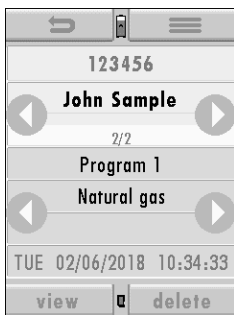

## 8.5. Measurements in Data storage

### View measurements

In the sub menu **view measurements** saved measurements can be viewed. When selected. First the number of saved measurements is displayed categorized by measurement types:

- Select gas measurement or any other available measurement.
- The basic information about saved measurements is being displayed, use the arrows to navigate between the saved measurements.
- Select **view** to view the saved measurement values. Measurements are saved the way the measurement screen has been set up.

Press **return** to return to the measurement basic information.

### Delete a measurement

You can:

- Delete single measurements by pressing the **delete** button when viewing the measurement.
- or delete all measurements in the main menu **storage** and the sub menu **Delete measurement**.

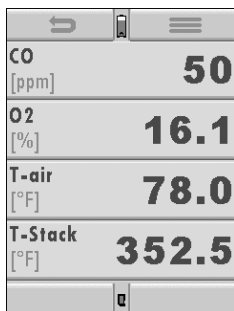

### **Transfer measurements to the SD card**

The analyzer offers the possibility to export all stored measurements to a SD card.

Insert SD card and select the main menu **storage** and sub menu **export CSV (SD)**, then select **Flue gas measurements** to transfer the measurements to the SD card.

During the data export the display reads „please wait“. A write error to SD card is reported by the instrument. Make sure that the SD card is not write protected.

The analyzer will confirm with: Data was exported.

The data are stored as a csv-file (e.g., EMI01032.csv) on the SD card. The file-name exists of a sequential number which fixes the device.

This file is editable on your Notebook/PC with a program like e.g. Microsoft® EXCEL or OpenOffice® Calc. With possible problems with the using of your computer programs please read your software documentations or ask your software dealer.

## **8.6. Data transfer to the PC (Sweeping district management programmes)**

### **What is necessary for a data transfer to a sweeping district management programme?**

The data memory can be transferred to a PC via USB. The MRU-ZIV module is required for this.

### **Which requirements are necessary on the PC?**

The DELTAsmart must be registered on the PC as a HID conform device.

**What does the MRU-ZIV module?**

The MRU-ZIV module is only used for data exchange. Via the USB cable the stored measurements can be read in the analyzer. It is also possible to transfer site data (site no., address, etc.) to the analyzer. The ZIV module transfers the stored measurements to a sweeping district management programme or receives the system data from the sweeping district management programme. The stored measurements can then be further used in the sweeping district management programme.

**How must the MRU-ZIV module be integrated into the sweeping district management programme?**

Please contact the developer of the program.

**How do I have to install the MRU-ZIV module?**

The software MRU-ZIV module can be found on the MRU product CD in the Software folder. During installation, the manual for the MRU-ZIV module is stored on your hard disk, which you can print out if necessary.

## 9 Extras

### Settings

The DELTAsmart is delivered with a pre-configured firmware which covers most of the needed applications. This unit can however be individually configured to meet anyone's needs.

#### 9.1. Service calibration menu

The service and calibration menu is pin code protected to assure the miss-use of unauthorized personnel.

When entering a wrong pin code, you will automatically be returned the extras menu.

Contact MRU or a MRU authorized dealer to get the pin code ([www.mru.eu](http://www.mru.eu)).

#### 9.2. Factory settings

All parameters will be reset to factory settings:

Parameters for measurement that have been modified by the user will be set to factory settings again.

Settings:

LCD brightness (%)50

Helping hints ON

Keyboard beep ON

All changes that have been made by the user (Combustion test) screen settings will be re-set to factory settings.

#### 9.3. Service values

In case of a defect sensor, which will be displayed after zeroing, the service values of all installed sensors and other parameters can be viewed in this menu.

When you experience a defect of a sensor you will most likely call in at MRU and they will ask you for these service values to identify the defect sensor or other defect parts. Each sensor will display a service value as well as other parts installed inside the analyzer.

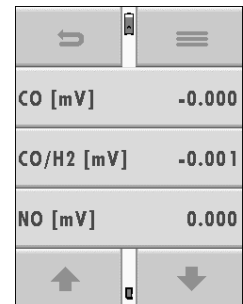
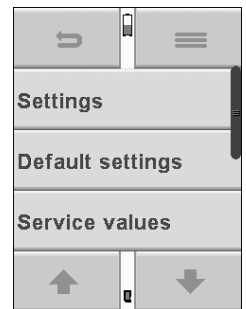
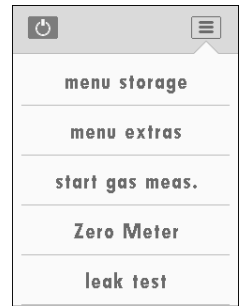

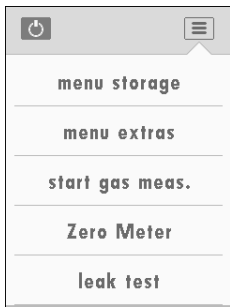

### 9.4. Analyzer and accessories leak test

When performing the leak tight test, the complete system including the probe, the sample line, the condensate separator and the analyzer are checked for leaks. The internal pump will create a vacuum, this vacuum is measured at the pressure sensor and the result will be displayed after 10 seconds of testing.



#### Performing the leak test

The leak test cap # 61382 (for probe tubes Ø 8 mm) must be placed on the tip of the probe tube.



#### NOTE

With dirt and soot particles on the probe tube the test cap will not seal properly.

► The probe tip must be cleaned before you start this test!

Test leak tight test will be started in the context menu using the **leak test** button.

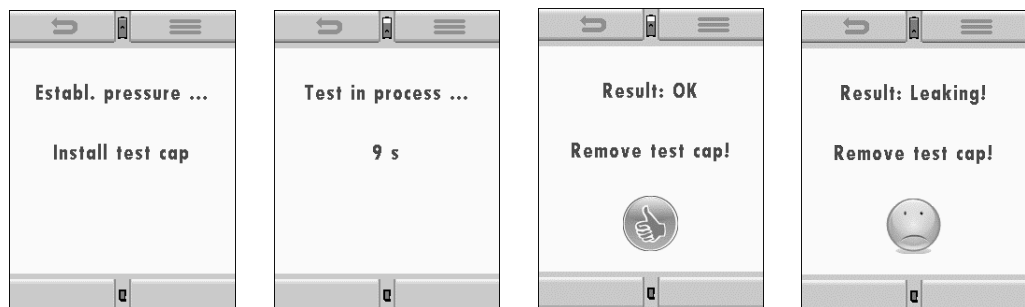

In case the test fails, you will have to check the probe, the hoses and the condensate separator for any damages or leakages. Contact your local MRU authorized dealer for further assistance if you can't locate any defects ([www.mru.eu](http://www.mru.eu)).

### 9.5. Analyzer information, Warranty-management and analyzer identification number

The analyzer information can be viewed in the main menu **extras** and the sub menu **Device info** (use context key).

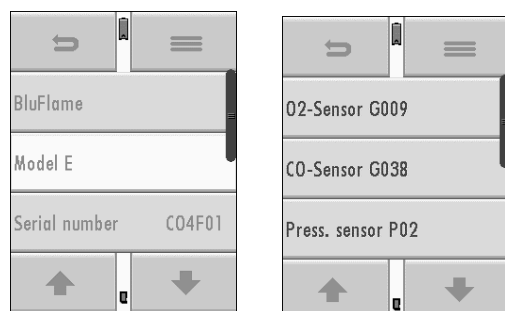

## 10 Maintenance

### 10.1. Cleaning

#### NOTE



Please note that correct operation of the analyzer is only ensured if the sensors are adjusted regularly.

- ▶ Depending on the intensity of use, the sensors have to be adjusted / calibrated 1-2 times a year.

Taking good care of your **DELTA**smart will ensure long-term maintenance value:

#### ⚠ CAUTION



#### Condensate is acidic

The condensate from the container can be slight acidic and can cause chemical burn.

- ▶ Immediately clean with plenty of water once you have encountered acid

- After each measurement: removed the hoses of the sampling from the **DELTA**smart and let them dry (condensate inside the hoses). Open and empty the condensate separator and let it dry.
- Occasionally: clean the sampling line.
- The pleated filter in the condensate separator can be washed 4 to 5 time (with your work clothes in the washing machine). The grade of contamination depends on the fuel types and the number of measurements performed. Replace the filter frequently when it looks dirty.

#### Care

- The internal battery has only a minor self-discharge effect. If the analyzer is not being used over a period it is recommended to charge the battery before storing it and then recharge the battery every 8 weeks.

### 10.2. Annual service and calibration

An annual service and calibration is highly recommended. Please contact your local service partner for details.

## 11 Appendix

### 11.1. Technical data

| <b>General data</b>                          |  |
|--|--|
| <b>Description</b>                           | <b>Values</b>                          |
| Operation temperature                        | +5°C - +45 °C / 41° F...<br>113° F     |
| Rel. Humidity when operating, not condensing | 95%                                    |
| Storage temperature                          | -20°C - +50°C / -4°F<br>...122° F      |
| Internal battery, operation hours            | Li-Ion, > 10h                          |
| Power supply                                 | 100 - 240 V / 5V DC /<br>500 mA        |
| Weight w/ 2 sensors                          | ca 500g / 1.1 lbs                      |
| Size   | 160 x 82 x 44 mm<br>6.3 x 3.2 x 1.7 in |
| Housing material                             | PA6                                    |
| IP degree of protection                      | IP30                                   |
| Max suction range gas pump                   | 150 hPa                                |
| gas flow typ.                                | 20 l/h                                 |
| Bluetooth frequency range and output power   | 2.402 GHz zo 2.480 GHz                 |
|  | BDR Power: 1,5* dBm                    |
|  | EDR (2M/3M) Power:<br>-1* dBm          |
|  | LE Power: 0,5 *dBm                     |
|  | *Typical values                        |
| <b>Measurement values</b>                    |  |
| <b>Electro-chemical sensor</b>               | <b>O<sub>2</sub></b>                   |
| Measurement range                            | 0 - 21 %                               |
| Resolution                                   | 0,1 Vol. %                             |
| Accuracy abs.                                | ± 0,2 Vol. %                           |
| Reaction time T90                            | < 30s                                  |
| Years expected lifetime (@air)               | 2                                      |
|  |  |
| <b>Electro-chemical sensor</b>               | <b>CO / H<sub>2</sub></b>              |
| H <sub>2</sub> compensated                   |  |
| Nom. Measuring Range                         | 0 – 4.000 ppm                          |
| Overload Range                               | < 10.000 ppm                           |
| Resolution                                   | 1 ppm                                  |
| Accuracy abs. / reading                      | ± 10 ppm                               |
|  | 5% (0 – 4.000 ppm)                     |

|                                |                     |
|--------------------------------|---------------------|
|                                | 10% (> 4.000 ppm)   |
| Response Time T90              | < 40s               |
| <b>Electro-chemical sensor</b> | <b>CO (#65929)</b>  |
| no H <sub>2</sub> compensation |                     |
| Nom. Measuring Range           | 0 – 10.000 ppm      |
| Overload Range                 | < 20.000 ppm        |
| Resolution                     | 1 ppm               |
| Accuracy abs./reading          | ± 10 ppm            |
|                                | 5% (0 – 10.000 ppm) |
|                                | 10 % (> 20.000 ppm) |
| Response Time T90              | < 30s               |

|   |                          |
|---|--------------------------|
| <b>Electro-chemical sensor</b>                    | <b>NO</b>                |
| Nom. Measuring Range                              | 0 – 5.000 ppm            |
| Overload Range                                    | < 10.000 ppm             |
| Resolution  | 1 ppm                    |
| Accuracy abs./reading                             | ± 5ppm                   |
|   | 5% (0 – 1.000 ppm)       |
|   | 10% (> 1.000 ppm)        |
| Response Time T90                                 | < 50s                    |
|   |                          |
| <b>Temperature measurement</b>                    | <b>T1, T2</b>            |
| Number of thermocouple type K input               | 2                        |
| Measuring Range                                   | -40 °C – 1.200 °C / ±2°C |
| Accuracy abs. / reading                           | 0,50%                    |
|   |                          |
| <b>Flue gas temperature (using MRU probe)</b>     | <b>T<sub>A</sub></b>     |
| Measurement range with stainless steel probe tube | 0 - 800°C                |
| Accuracy abs. / reading                           | ±2°C / 0,50%             |
|   |                          |
| <b>Ambient temperature (with MRU sensors)</b>     | <b>T<sub>I</sub></b>     |
| Measuring Range with ambient temperature probe    | 0 - 100°C                |
| Accuracy  | 1 °C                     |
| Accuracy abs./reading                             | ±1°C                     |
|   |                          |
| <b>Draft</b>                                      |                          |
| Measurement range                                 | ± 200 hPa                |
| Accuracy abs. / reading                           | 0,02 hPa / 1%            |
|   |                          |
|   |                          |
| <b>Differential pressure</b>                      |                          |

|  |               |
|--|---------------|
| Measurement range                        | ± 200 hPa     |
| Accuracy absolute / of measurement value | 0,02 hPa / 1% |

|   |  |
|---|--|
| <b>Calculated values</b>                |  |
|   | <b>CO<sub>2</sub></b>                                |
| Measurement range (fuel type dependent) | 0 - CO <sub>2</sub> max                              |
| Accuracy abs.                           | ± 0,3 Vol. %   |
|   |  |
| <b>Air ratio</b>                        |  |
| Measuring Range                         | 1 - 20   |
|   |  |
| <b>Excess air</b>                       |  |
| Measurement range                       | 0 - 999 %  |
|   |  |
| <b>PI (Poison Index / Ratio)</b>        |  |
| Measurement range                       | 0,0001 - 10.0  |
|   |  |
| <b>Dewpoint</b>                         |  |
|   | °F   |
|   |  |
| <b>Losses qA</b>                        |  |
| Measurement range                       | 0 – 99,9%  |
|   |  |
| <b>Efficiency</b>                       |  |
| Measurement range                       | 0 - 120%   |
|   |  |
| Measurement can be displayed as         | Mg/Nm <sup>3</sup>                                   |
|   | O <sub>2</sub> Ref                                   |
|   | mg/kWh   |
|   | NO <sub>x</sub> : mg/Nm <sub>3</sub> NO <sub>2</sub> |

## 11.2. Analysis and calculations

| Continuous measured parameter      | UNIT             |
|------------------------------------|------------------|
| O <sub>2</sub>                     | [%]              |
| Temp. Ambient air (Thermo-Element) | [°F]             |
| Temp. Exhaust gas (Thermo-Element) | [°F]             |
| CO                                 | [ppm]            |
| Draft                              | [hPa] and others |

| Continuous calculated to CO   | CO | NO |
|---|----|----|
| [ppm] ref. to 0% rest O <sub>2</sub> (undiluted)                                | X  | X  |
| [ppm] ref. to fuel type dependent O <sub>2</sub> reference value                | X  | X  |
| [mg/m <sup>3</sup> ]  | X  | X  |
| [mg/kWh]  | X  | X  |
| [mg/MJ]   | X  | X  |
| [mg/m <sup>3</sup> ] ref. to fuel type dependent O <sub>2</sub> reference value | X  | X  |

| Addition continuous calculated values |
|---------------------------------------|
| CO <sub>2</sub>                       |
| Eff. Net                              |
| Eff. Gross                            |
| Losses Net                            |
| Losses Gross                          |
| Exc. Air                              |
| Lambda                                |
| Dewpoint                              |
| CO / CO <sub>2</sub> ratio            |

### 11.3. Fuel type lists

This list is valid only for Germany.

Information on fuels for other countries can be requested from MRU.

Website: [www.mru.eu](http://www.mru.eu)

| Germany          |                  |                     | O <sub>2</sub> max | 20,96 |       |
|------------------|------------------|---------------------|--------------------|-------|-------|
| Fuel type        | Fuel type        | CO <sub>2</sub> max | A1                 | A2    | B     |
| Prüfgas          | Test gas         | 0,0                 | 0,00               | 0,00  | 0,000 |
| Erdgas (LL)      | Natural gas (LL) | 11,8                | 0,37               | 0,66  | 0,009 |
| Erdgas (E) (*)   | Natural gas (E)  | 12,1                | 0,37               | 0,64  | 0,009 |
| Heizöl EL        | Oil EL           | 15,4                | 0,50               | 0,68  | 0,007 |
| Heizöl S         | Oil S            | 15,9                | 0,50               | 0,66  | 0,007 |
| Flüssiggas P / B | Gas P/B          | 13,7                | 0,42               | 0,63  | 0,008 |
| Propan           | Propane          | 13,7                | 0,43               | 0,66  | 0,007 |
| Butan            | Butane           | 14,1                | 0,45               | 0,67  | 0,007 |
| Bio-Diesel       | Bio-Diesel       | 15,7                | 0,46               | 0,62  | 0,005 |
| Holz trocken     | Wood dry         | 20,3                | 0,60               | 0,62  | 0,009 |
| Pellets          | Pellets          | 20,3                | 0,74               | 0,77  | 0,000 |
| Kohle            | Coal             | 19,1                | 0,59               | 0,65  | 0,009 |
| Braunkohle       | Brown coal       | 19,4                | 0,39               | 0,42  | 0,009 |
| Torf             | Peat             | 19,8                | 0,66               | 0,70  | 0,010 |
| Kokereigas       | Coke oven gas    | 10,8                | 0,29               | 0,60  | 0,011 |
| Stadtgas         | Illuminating gas | 11,7                | 0,35               | 0,63  | 0,011 |

(\*) – not installed in the analyzer, can be added if needed as a **user fuel type**.

Fuel types from other countries can be obtained from MRU GmbH:

Web page: [www.mru.eu](http://www.mru.eu)

## Firmware updates

### Check the analyzer firmware

- Power on the analyzer then press the **context** button and then the **extras** menu and the sub menu **device info**.
- The 4th line will display the installed firmware version:  
e.g.: 1.07.07
- We will need the following analyzer information in case the update fails.
- Please make a note of the analyzer serial number and installed firmware version.

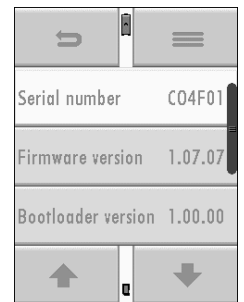

### Perform and check an update

#### Preparing the SD card

In case you have received the firmware by email, you might first have to extract it if it came in a ZIP file. The unzipped file "1107.fwb" must then be copied onto the SD card (root directory, which means not in a sub-folder).

#### IMPORTANT:

**Please make sure that your battery has at least 60% capacity when making an update!**

#### Perform an update:

- Insert the SD card into the analyzer SD card slot (the SD card pins must face to top (towards the user), the power up the analyzer.  
The SD card can be removed by slightly pressing the card into the analyzer and then let go.
- The analyzer will display „found new firmware on the flash disk!“
- Select install firmware.
- The update procedure will start...
- This procedure takes about 45 seconds.
- Once completed you must restart the analyzer.
- done



#### How to check if the update was successful?

Press the **context** button and select **extras** and then the sub menu **Device info**, the 4<sup>th</sup> line will display the installed firmware version.

#### What to do when the update has not been performed?

Repeat the steps above.

#### Where do I get help to resolve issues?

Contact your local service center for help.

## 11.4. Troubleshooting

### Troubleshooting your analyzer

| Effect                                  | Fault  | Reason   | Solution   |
|---|--|--|--|
| Analyzer shows no reaction              |  | Analyzer shows no reaction when touching the screen  | Make an analyzer reset (reset button)  |
| Analyzer is too cold and can't be used. | Display – <b>analyzer too cold</b> or a beep every 5 seconds                     | e.g. analyzer was outside in winter or cold nights (days)  | Take analyzer to a warm room and let it warm up  |
| Measurement results are not ok          | Faulty zeroing   | Sensors were exposed to gas during zeroing   | Purge analyzer with fresh air and re-zero  |
| Analyzer can't be powered on            |  | Battery empty  | Connect the charger to the analyzer to charge the battery  |
| No temperature values                   | Temperature display:<br>- - - , - °F   | Defect thermo-element, or a defect cable or plug not connected                                     | Remove probe from stack and let it cool off. Call your service department if everything looks good but you still don't get any readings. |
| Wrong Combustion Test results           | O <sub>2</sub> -values are too high, CO- and CO <sub>2</sub> -values are too low | Bad probe connection, leaking condensate separator or gas pump not working properly                | Perform a leak test, check probe, sampling line and condensate separator for defects   |
| Temperature values seem to be off       | Gas temperature too high or jumping values                                       | Defect thermo-element, or a defect cable or plug not connected / condensate on the thermos-element | Remove probe from stack and let it cool off. Check all components and remove condensate from thermos-element                             |

### Troubleshooting the condensate separator

| Effect  | Reason  | Solution  |
|---|---|---|
| Dirt and / or moisture inside the analyzer.<br>Sensors have failed<br>Gas pump has failed | Dirty or wet filter   | Check and replace filters more frequently,<br>Filter öfters überprüfen<br>ggf. austauschen<br>(white = O.K.<br>Brown / black / wet = replace) |
| Wrong Combustion Test results   | The connections of the condensate separator are not leak tight / missing seal | Perform a leak test every time the condensate separator had been opened or a filter had been replaced   |

### 11.5. O-Ring Set for DELTA<sub>smart</sub>

#### 65875 O-Ring Set

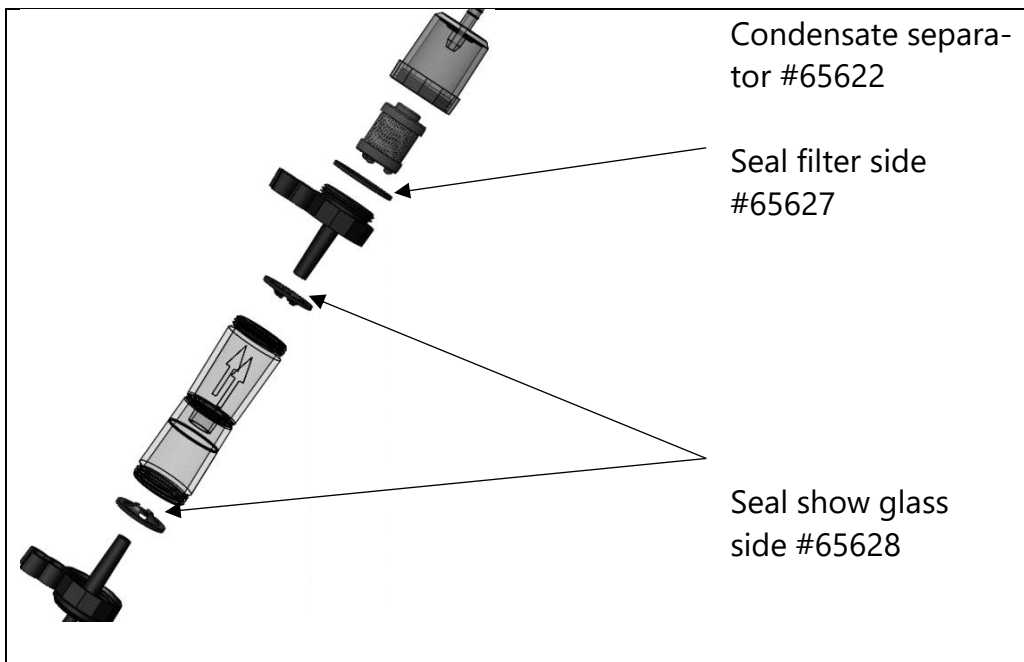



**MRU · Messgeräte für Rauchgase  
und Umweltschutz GmbH**

Fuchshalde 8 + 12

74172 Neckarsulm-Obereisesheim

Fon 07132 99620 · Fax 07132 996220

info@mru.de · www.mru.eu